

# 2022 NINJA® ZX™ -10R PARTS DIAGRAM

Seat

F2510

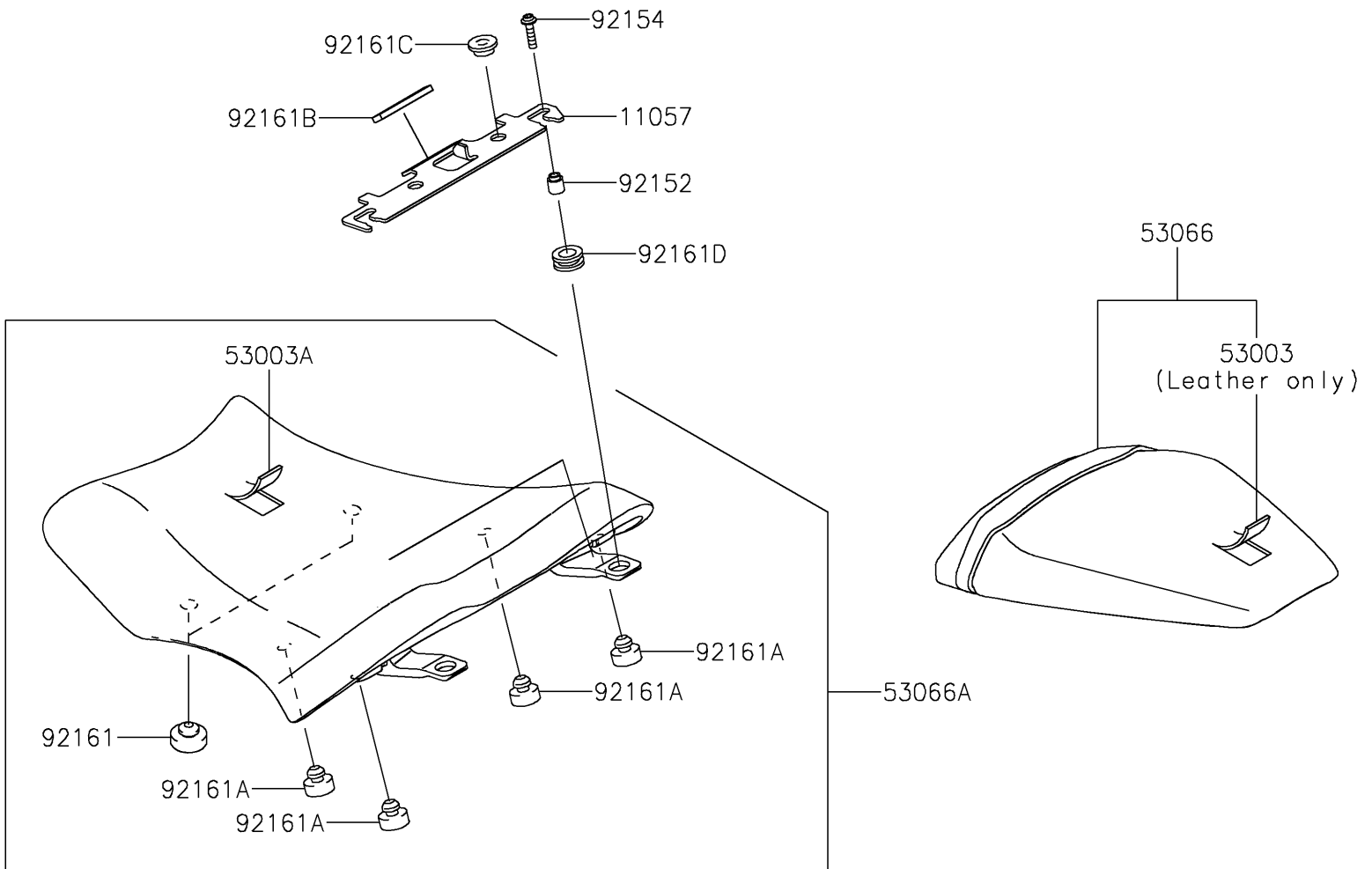

## 2022 NINJA® ZX™ -10R PARTS LIST

### Seat

| ITEM NAME                              | PART NUMBER    | QUANTITY |
|--|----------------|----------|
| BRACKET,SEAT (Ref # 11057)             | 11057-7381     | 1        |
| LEATHER,RR SEAT,BLACK (Ref # 53003)    | 53003-0420-MA  | 1        |
| LEATHER,FR SEAT,BLACK (Ref # 53003A)   | 53003-0535-MA  | 1        |
| SEAT-ASSY,RR,BLACK/BLACK (Ref # 53066) | 53066-0506-12Y | 1        |
| SEAT-ASSY,FR,BLACK (Ref # 53066A)      | 53066-0700-MA  | 1        |
| COLLAR (Ref # 92152)                   | 92152-2816     | 2        |
| BOLT,SOCKET,5X20 (Ref # 92154)         | 92154-4257     | 2        |
| DAMPER,SEAT,10X25X8 (Ref # 92161)      | 92161-0095     | 2        |
| DAMPER,8X20X8 (Ref # 92161A)           | 92161-0223     | 4        |
| DAMPER,10X50X4 (Ref # 92161B)          | 92161-1834     | 1        |
| DAMPER,6X20X7.5 (Ref # 92161C)         | 92161-1937     | 2        |
| DAMPER (Ref # 92161D)                  | 92161-2403     | 2        |