

2023 Vulcan® 900 Classic PARTS DIAGRAM

Footrests

F2160

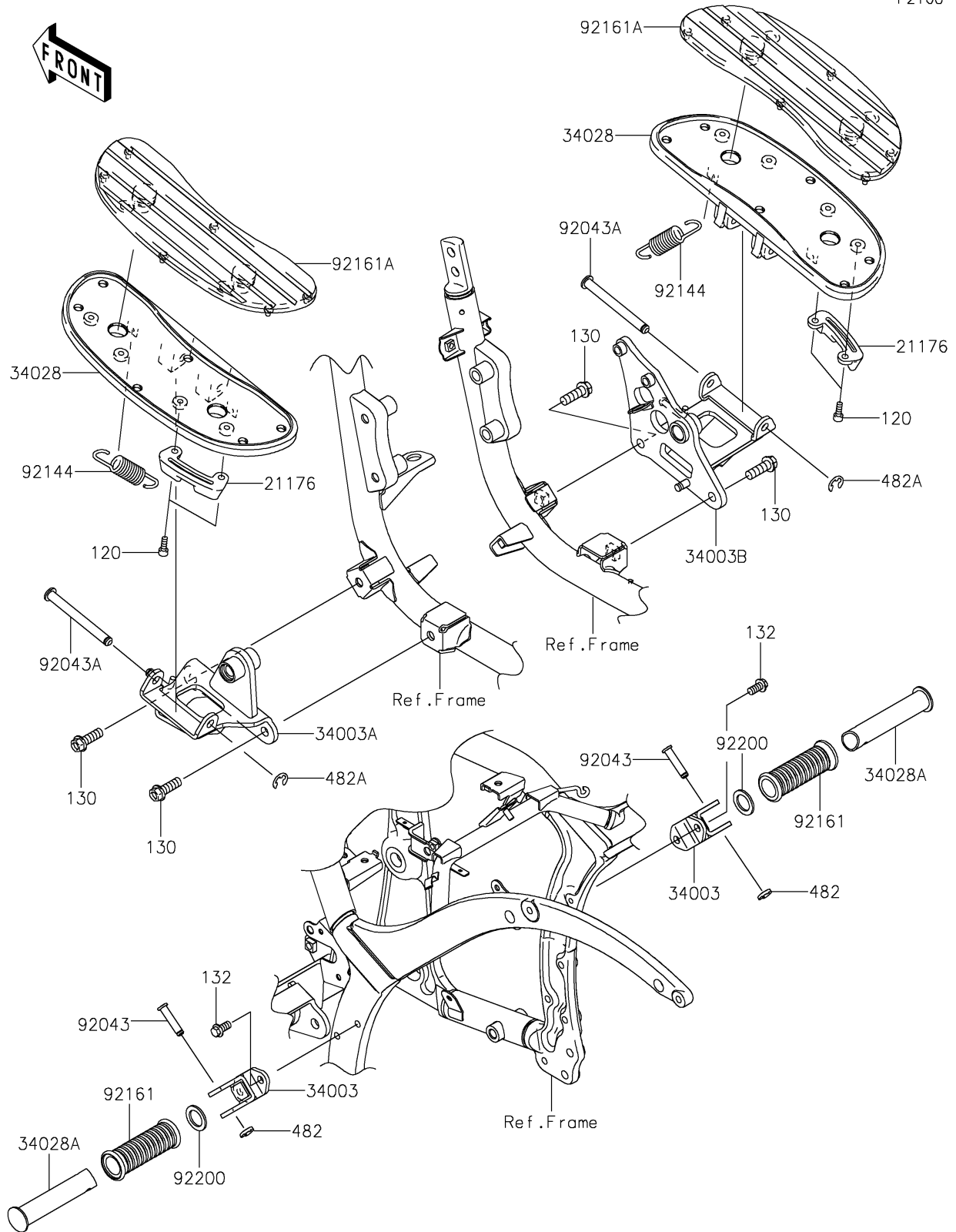

2023 Vulcan® 900 Classic PARTS LIST

Footrests

ITEM NAME	PART NUMBER	QUANTITY
SENSOR,BANK (Ref # 21176)	21176-0021	2
HOLDER-STEP,RR,F.S.BLACK (Ref # 34003)	34003-0030-18R	2
HOLDER-STEP,FR,LH (Ref # 34003A)	34003-0039	1
HOLDER-STEP,FR,RH (Ref # 34003B)	34003-0050	1
STEP,FR (Ref # 34028)	34028-0011	2
STEP,RR (Ref # 34028A)	34028-0017	2
PIN,8X36.5 (Ref # 92043)	92043-1339	2
PIN,10X98.5 (Ref # 92043A)	92043-1707	2
SPRING (Ref # 92144)	92144-1266	2
DAMPER,STEP (Ref # 92161)	92161-0232	2
DAMPER,FRONT STEP (Ref # 92161A)	92161-1325	2
WASHER,22.5X33X2.3 (Ref # 92200)	92200-1482	2
BOLT-SOCKET,6X16 (Ref # 120)	120CB0616	4
BOLT-FLANGED,10X30 (Ref # 130)	130BB1030	4
BOLT-FLANGED-SMALL,8X16 (Ref # 132)	132BB0816	4
CIRCLIP-TYPE-E (Ref # 482)	482EA7000	2
CIRCLIP-TYPE-E,8MM (Ref # 482A)	482EA8000	2