

2024 VULCAN® S PARTS DIAGRAM

Valve(s)

E1210

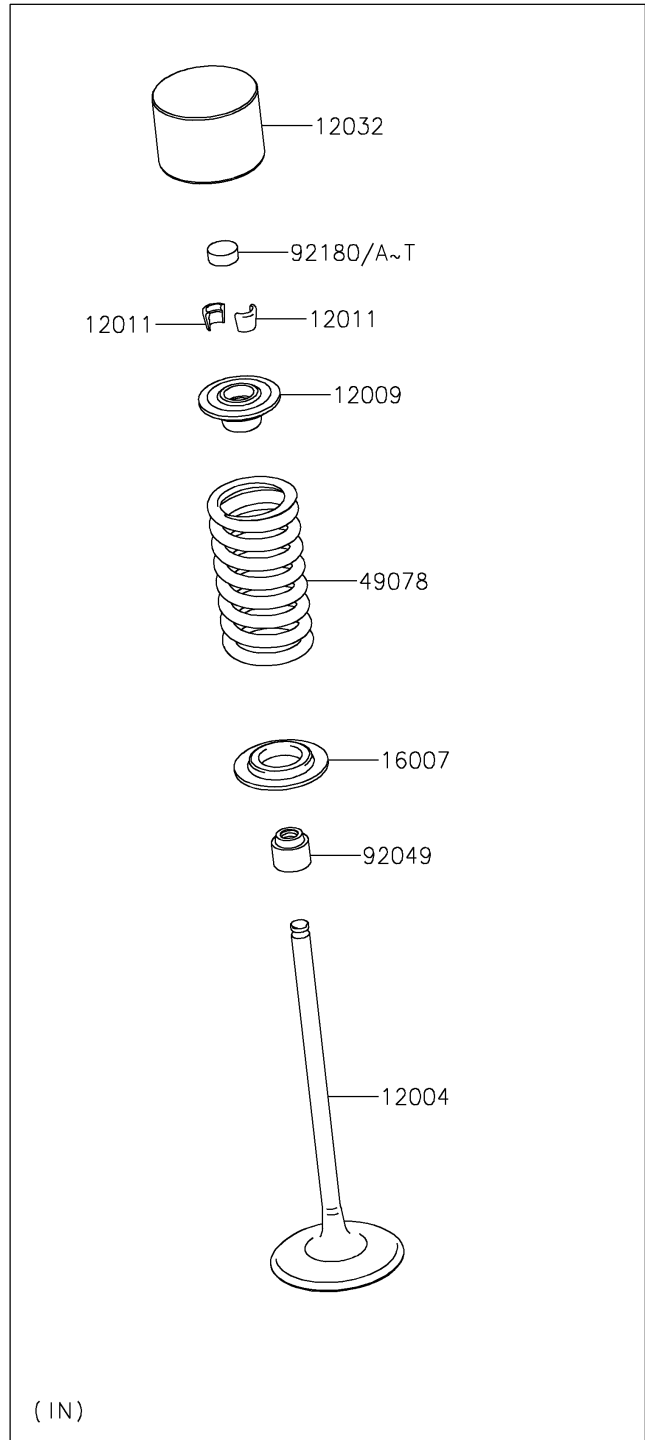
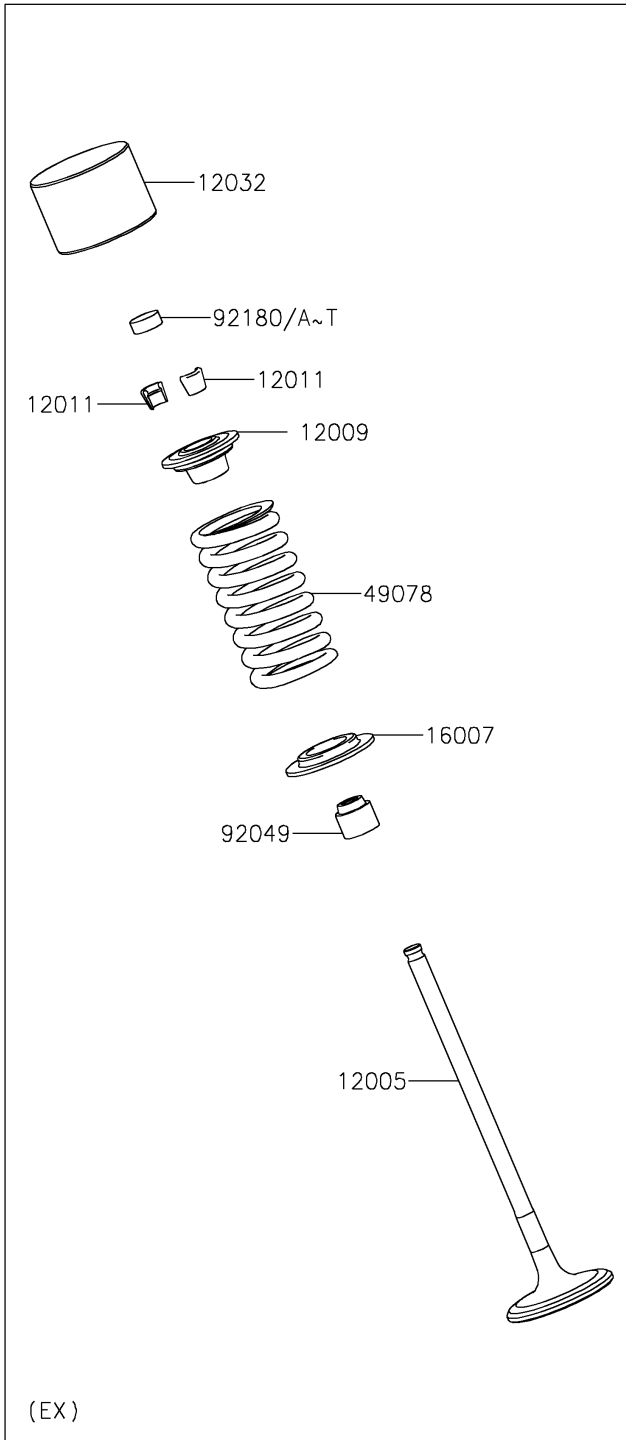

2024 VULCAN® S PARTS LIST

Valve(s)

| ITEM NAME | PART NUMBER | QUANTITY |
|--|-------------|----------|
| VALVE-INTAKE (Ref # 12004) | 12004-0706 | 4 |
| VALVE-EXHAUST (Ref # 12005) | 12005-0742 | 4 |
| RETAINER-VALVE SPRING (Ref # 12009) | 12009-1091 | 8 |
| COLLET (Ref # 12011) | 12011-1053 | 16 |
| TAPPET (Ref # 12032) | 12032-0017 | 8 |
| SEAT-SPRING (Ref # 16007) | 16007-1228 | 8 |
| SPRING-ENGINE VALVE (Ref # 49078) | 49078-0065 | 8 |
| SEAL-OIL,VSB 4.3 7.5 5.3 8.3 (Ref # 92049) | 92049-1349 | 8 |
| SHIM,T=2.50 (Ref # 92180) | 92180-1014 | AR |
| SHIM,T=2.55 (Ref # 92180A) | 92180-1016 | AR |
| SHIM,T=2.60 (Ref # 92180B) | 92180-1018 | AR |
| SHIM,T=2.65 (Ref # 92180C) | 92180-1020 | AR |
| SHIM,T=2.70 (Ref # 92180D) | 92180-1022 | AR |
| SHIM,T=2.75 (Ref # 92180E) | 92180-1024 | AR |
| SHIM,T=2.80 (Ref # 92180F) | 92180-1026 | AR |
| SHIM,T=2.85 (Ref # 92180G) | 92180-1028 | AR |
| SHIM,T=2.90 (Ref # 92180H) | 92180-1030 | AR |
| SHIM,T=2.95 (Ref # 92180I) | 92180-1032 | AR |
| SHIM,T=3.00 (Ref # 92180J) | 92180-1034 | 8 |
| SHIM,T=3.05 (Ref # 92180K) | 92180-1036 | AR |
| SHIM,T=3.10 (Ref # 92180L) | 92180-1038 | AR |
| SHIM,T=3.15 (Ref # 92180M) | 92180-1040 | AR |
| SHIM,T=3.20 (Ref # 92180N) | 92180-1042 | AR |
| SHIM,T=3.25 (Ref # 92180O) | 92180-1044 | AR |
| SHIM,T=3.30 (Ref # 92180P) | 92180-1046 | AR |
| SHIM,T=3.35 (Ref # 92180Q) | 92180-1048 | AR |
| SHIM,T=3.40 (Ref # 92180R) | 92180-1050 | AR |
| SHIM,T=3.45 (Ref # 92180S) | 92180-1052 | AR |
| SHIM,T=3.50 (Ref # 92180T) | 92180-1054 | AR |