

2023 Vulcan S PARTS DIAGRAM

Accessory(Fender Strut Cover)

F2910J

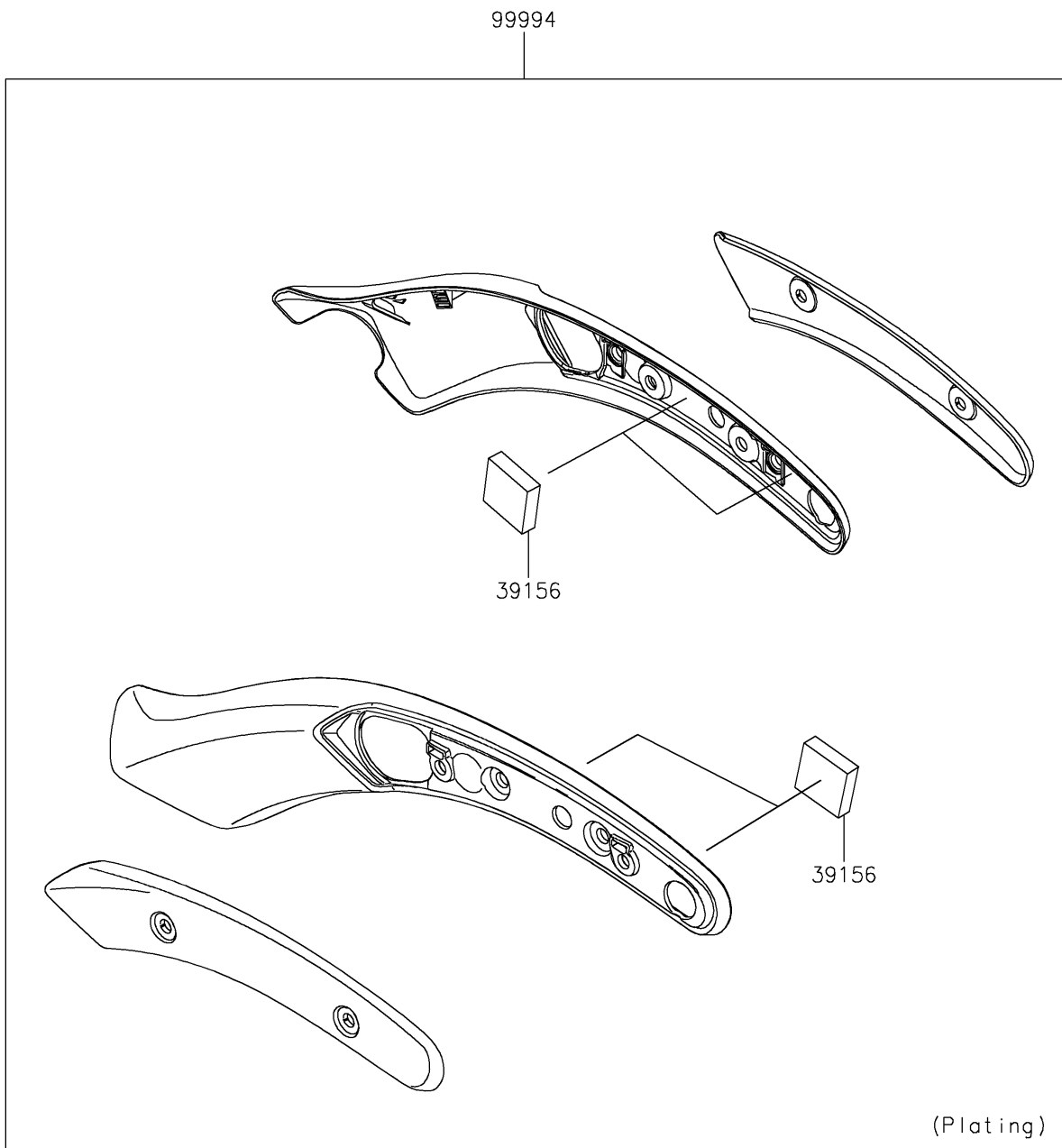

2023 Vulcan S PARTS LIST

Accessory(Fender Strut Cover)

ITEM NAME	PART NUMBER	QUANTITY
PAD,35X35X10 (Ref # 39156)	39156-1901	4
KIT.,FENDER STRUT COVER (Ref # 99994)	99994-0535	1