

2025 Ninja ZX-4R ABS PARTS DIAGRAM

Fuel Injection

E1530

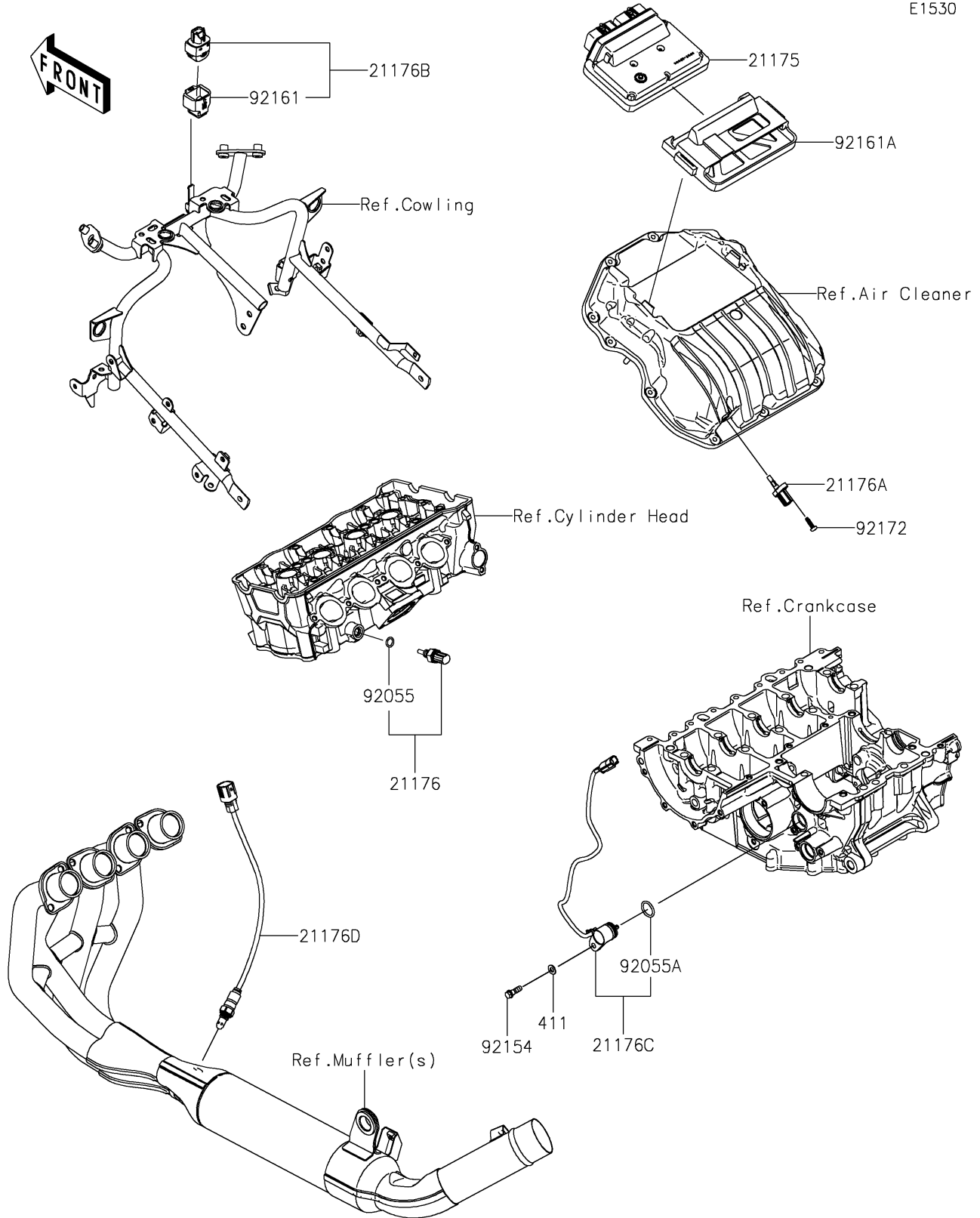

2025 Ninja ZX-4R ABS PARTS LIST

Fuel Injection

ITEM NAME	PART NUMBER	QUANTITY
CONTROL UNIT-ELECTRONIC (Ref # 21175)	21175-1855	1
SENSOR,WATER TEMP (Ref # 21176)	21176-0009	1
SENSOR,AIR TEMPERATURE (Ref # 21176A)	21176-0048	1
SENSOR,VEHICLE-DOWN (Ref # 21176B)	21176-0704	1
SENSOR,GEAR POSITION (Ref # 21176C)	21176-0852	1
SENSOR,OXYGEN (Ref # 21176D)	21176-0931	1
RING-O,9.5X1.9 (Ref # 92055)	92055-0016	1
RING-O (Ref # 92055A)	92055-0917	1
BOLT (Ref # 92154)	92154-3764	1
DAMPER (Ref # 92161)	92161-0951	1
DAMPER,ECU (Ref # 92161A)	92161-2487	1
SCREW,TAPPING,5X16 (Ref # 92172)	92172-0790	1
WASHER-PLAIN,6MM (Ref # 411)	411AA0600	1