

2025 Ninja ZX-4R ABS PARTS DIAGRAM

Suspension/Shock Absorber

F2151

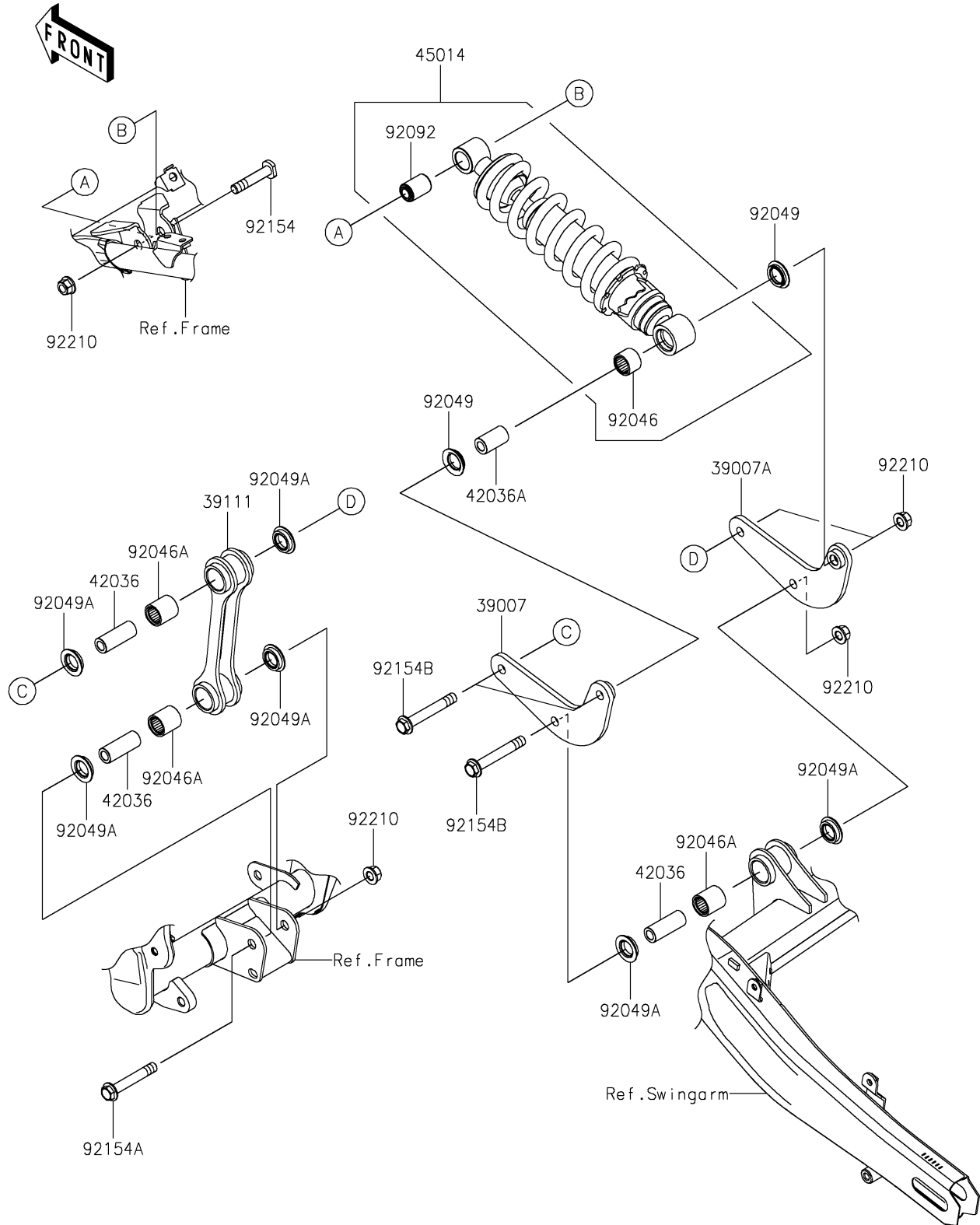

2025 Ninja ZX-4R ABS PARTS LIST

Suspension/Shock Absorber

ITEM NAME	PART NUMBER	QUANTITY
ARM-SUSP,LH (Ref # 39007)	39007-0507	1
ARM-SUSP,RH (Ref # 39007A)	39007-0508	1
ROD-TIE (Ref # 39111)	39111-0392	1
SLEEVE,10.1X17X44.5 (Ref # 42036)	42036-0718	3
SLEEVE,10.1X18X32 (Ref # 42036A)	42036-1344	1
SHOCKABSORBER (Ref # 45014)	45014-0782	1
BEARING-NEEDLE,SFYZM182417 (Ref # 92046)	92046-1272	1
BEARING-NEEDLE,SFYZM172425 (Ref # 92046A)	92046-1273	3
SEAL-OIL (Ref # 92049)	92049-0133	2
SEAL-OIL,MHA17245.7F (Ref # 92049A)	92049-0850	6
BUSHING-RUBBER (Ref # 92092)	92092-0041	1
BOLT,10X50 (Ref # 92154)	92154-2165	1
BOLT,FLANGED,10X63 (Ref # 92154A)	92154-4256	1
BOLT,FLANGED,10X70 (Ref # 92154B)	92154-4434	3
NUT,LOCK,FLANGED,10MM (Ref # 92210)	92210-1139	5