

2023 Ninja ZX-4R ABS PARTS DIAGRAM

Handlebar

F2310

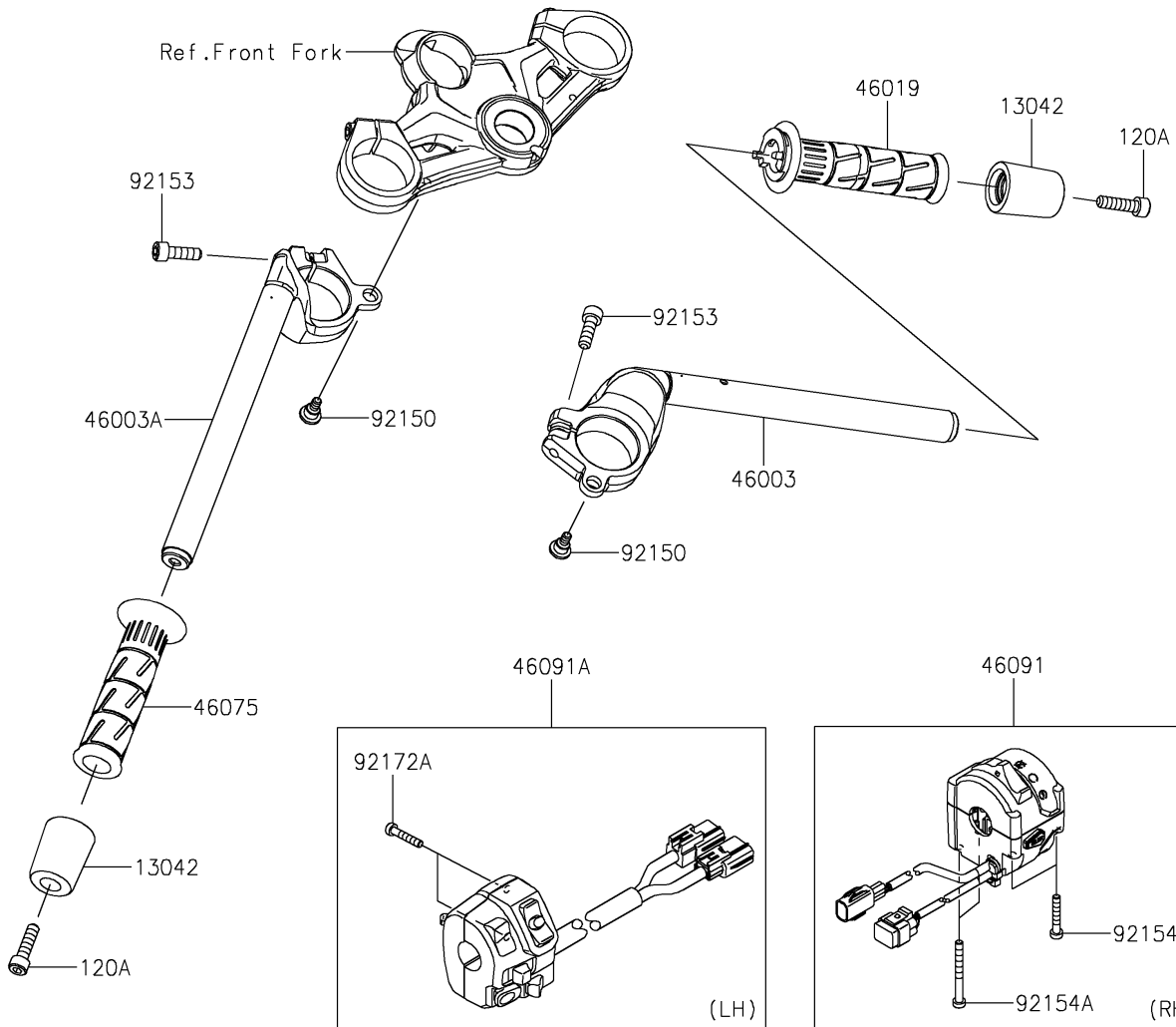
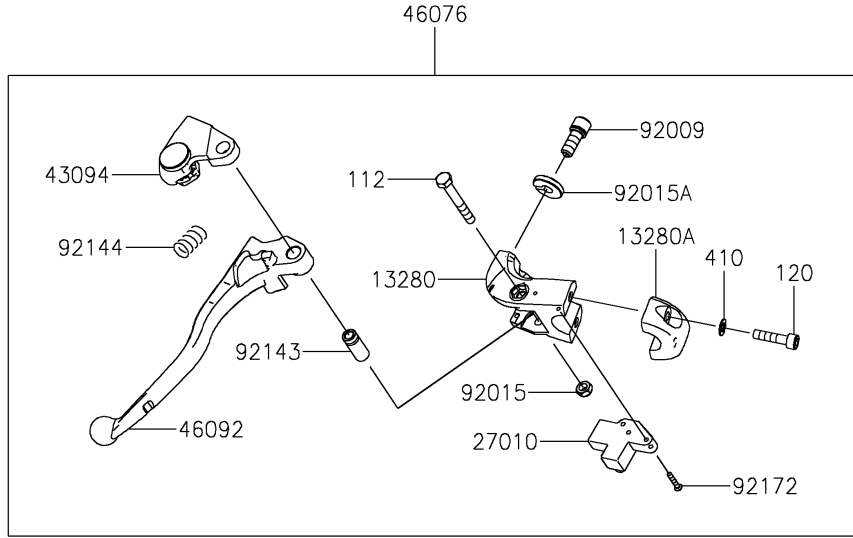

2023 Ninja ZX-4R ABS PARTS LIST

Handlebar

ITEM NAME	PART NUMBER	QUANTITY
WEIGHT,HANDLE (Ref # 13042)	13042-5040	2
HOLDER,CLUTCH LEVER (Ref # 13280)	13280-0306	1
HOLDER,CLUTCH LEVER (Ref # 13280A)	13280-0319	1
SWITCH,CLUTCH (Ref # 27010)	27010-0933	1
ADJUSTER (Ref # 43094)	43094-0013	1
HANDLE,RH (Ref # 46003)	46003-0762	1
HANDLE,LH (Ref # 46003A)	46003-0822	1
GRIP-ASSY,THROTTLE (Ref # 46019)	46019-0100	1
GRIP,HANDLE,LH (Ref # 46075)	46075-0564	1
LEVER-ASSY-GRIP,CLUTCH (Ref # 46076)	46076-0174	1
HOUSING-ASSY-CONTROL,RH (Ref # 46091)	46091-0586	1
HOUSING-ASSY-CONTROL,LH (Ref # 46091A)	46091-0587	1
LEVER-GRIP,CLUTCH (Ref # 46092)	46092-0578	1
SCREW,CABLE ADJUST,8MM,BLACK (Ref # 92009)	92009-1134	1
NUT,LOCK,6MM,BLACK (Ref # 92015)	92015-1191	1
NUT,CABLE ADJUST LOCK,8MM,BLK (Ref # 92015A)	92015-1197	1
COLLAR (Ref # 92143)	92143-1379	1
SPRING (Ref # 92144)	92144-1467	1
BOLT,6MM (Ref # 92150)	92150-1090	2
BOLT,SOCKET,8X25 (Ref # 92153)	92153-1625	2
BOLT,5X30 (Ref # 92154)	92154-3921	2
BOLT,5X50 (Ref # 92154A)	92154-3922	2
SCREW,3X16 (Ref # 92172)	92172-0183	2
SCREW-PAN-CROS,5X25 (Ref # 92172A)	92172-1140	2
BOLT-UPSET,6X45 (Ref # 112)	112BB0645	1
BOLT-SOCKET,6X25 (Ref # 120)	120CB0625	2
BOLT-SOCKET,8X30 (Ref # 120A)	120CB0830	2
WASHER-PLAIN-SMALL,6MM (Ref # 410)	410AB0600	2