

2025 Ninja ZX-4R ABS PARTS DIAGRAM

Meter(s)

F2530

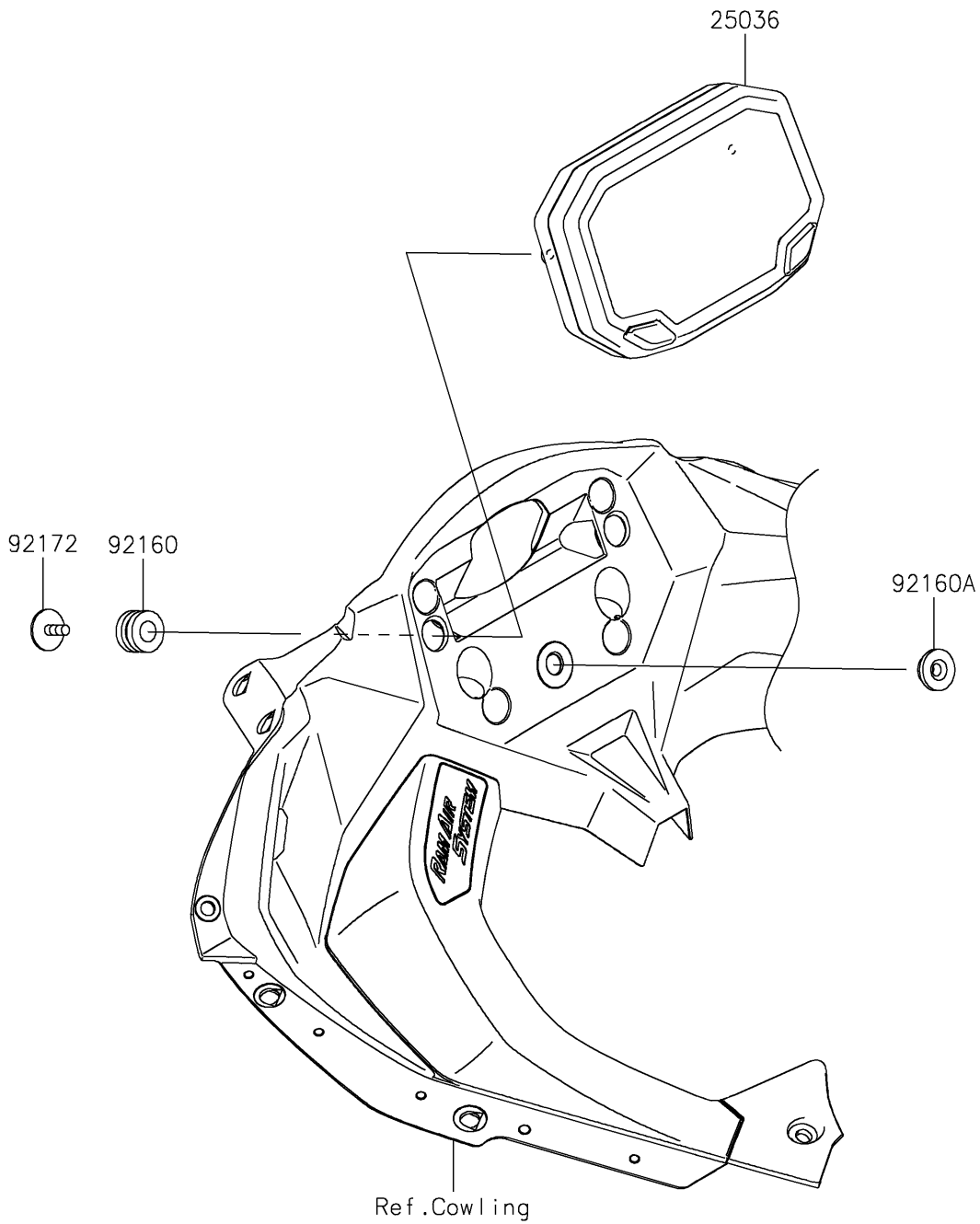

2025 Ninja ZX-4R ABS PARTS LIST

Meter(s)

ITEM NAME	PART NUMBER	QUANTITY
METER-ASSY,TFT DISPLAY (Ref # 25036)	25036-0128	1
DAMPER,10X20X12 (Ref # 92160)	92160-1167	2
DAMPER (Ref # 92160A)	92160-1613	1
SCREW,CROSS,5X14 (Ref # 92172)	92172-1226	2