

2023 Ninja ZX-4R ABS PARTS DIAGRAM

Chassis Electrical Equipment

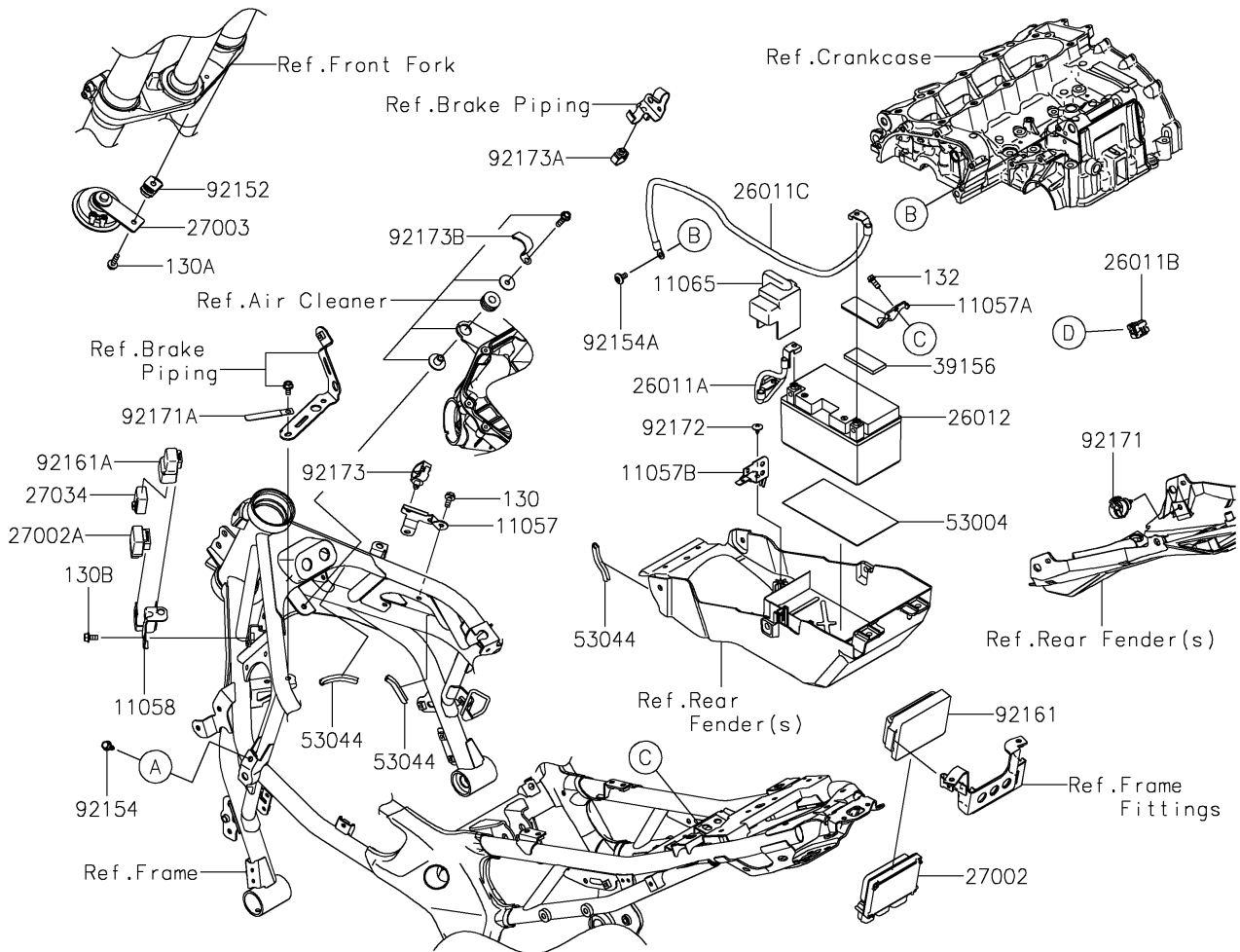
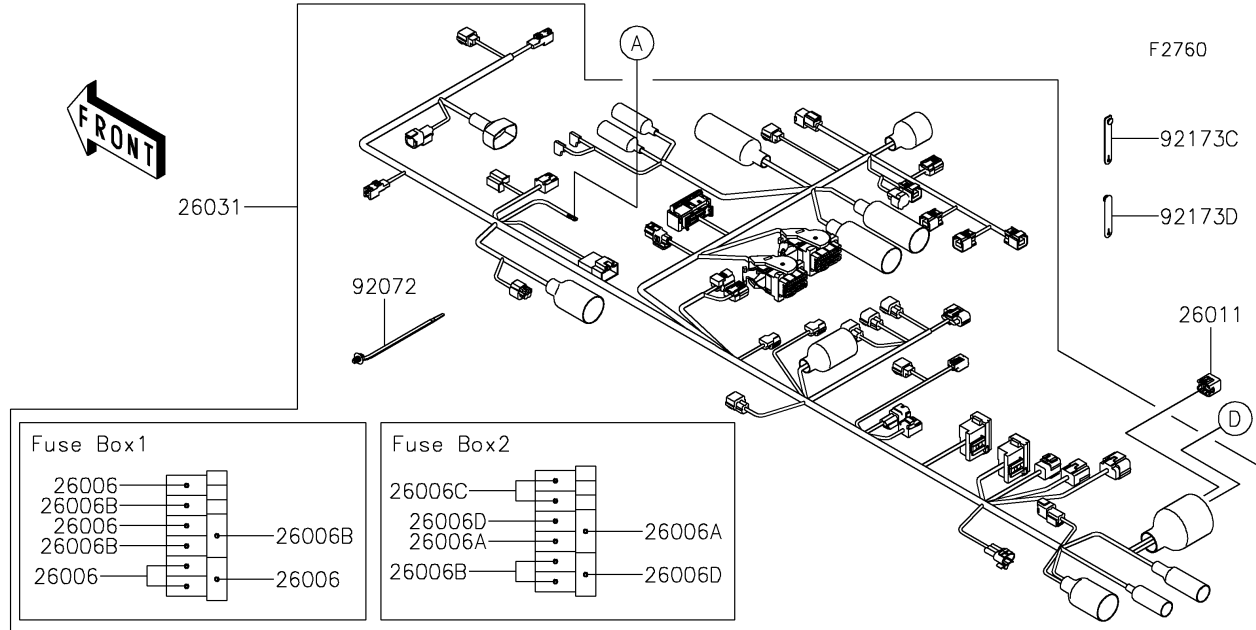

2023 Ninja ZX-4R ABS PARTS LIST

Chassis Electrical Equipment

ITEM NAME	PART NUMBER	QUANTITY
BRACKET,FRAME,RH (Ref # 11057)	11057-2877	1
BRACKET,BATTERY MOUNT (Ref # 11057A)	11057-2926	1
BRACKET,RR FENDER (Ref # 11057B)	11057-7041	1
BRACKET,RELAY (Ref # 11058)	11058-0349	1
CAP,MAGNETIC SWITCH (Ref # 11065)	11065-1352	1
FUSE,MINI BLADE,15A,BLUE (Ref # 26006)	26006-0001	5
FUSE,MINI BLADE,5A,TAN (Ref # 26006A)	26006-1077	2
FUSE,MINI BLADE,10A,RED (Ref # 26006B)	26006-1078	5
FUSE,MINI BLADE,20A,YELLOW (Ref # 26006C)	26006-1079	2
FUSE,MINI BLADE,30A,GREEN (Ref # 26006D)	26006-1080	2
WIRE-LEAD,CONNECTOR COVER (Ref # 26011)	26011-0275	1
WIRE-LEAD,BATTERY(+) (Ref # 26011A)	26011-1896	1
WIRE-LEAD,DIAG CONNECTOR (Ref # 26011B)	26011-1901	1
WIRE-LEAD,BATTERY(-) (Ref # 26011C)	26011-2425	1
BATTERY,YTZ10,12V 8.6AH (Ref # 26012)	26012-1606	1
HARNESS,MAIN (Ref # 26031)	26031-4113	1
RELAY-ASSY (Ref # 27002)	27002-0061	1
RELAY-ASSY,SIGNAL LAMP (Ref # 27002A)	27002-0068	1
HORN (Ref # 27003)	27003-0124	1
RELAY (Ref # 27034)	27034-0012	1
PAD,56X25X5 (Ref # 39156)	39156-2808	1
MAT,BATTERY (Ref # 53004)	53004-0560	1
TRIM (Ref # 53044)	53044-0565	3
BAND,OS170-FT7(BLACK) (Ref # 92072)	92072-1414	AR
COLLAR (Ref # 92152)	92152-2657	1
BOLT,FLANGED,6X16 (Ref # 92154)	92154-0551	1
BOLT,SOCKET,6X12 (Ref # 92154A)	92154-2355	1
DAMPER,RELAY BOX (Ref # 92161)	92161-0203	1
DAMPER (Ref # 92161A)	92161-2290	1

2023 Ninja ZX-4R ABS PARTS LIST

Chassis Electrical Equipment

ITEM NAME	PART NUMBER	QUANTITY
CLAMP,CLIP,DIA=20 (Ref # 92171)	92171-0068	1
CLAMP,L=60 (Ref # 92171A)	92171-0652	1
SCREW,TAPPING,6X12 (Ref # 92172)	92172-0003	1
CLAMP (Ref # 92173)	92173-0861	1
CLAMP,HOLDER CLIP (Ref # 92173A)	92173-0868	1
CLAMP (Ref # 92173B)	92173-1549	1
CLAMP (Ref # 92173C)	92173-2194	1
CLAMP (Ref # 92173D)	92173-2199	2
BOLT-FLANGED,6X14 (Ref # 130)	130BA0614	2
BOLT-FLANGED,6X20 (Ref # 130A)	130BA0620	1
BOLT-FLANGED,6X12 (Ref # 130B)	130CA0612	1
BOLT-FLANGED-SMALL,6X14 (Ref # 132)	132BC0614	1