

2003 Ninja® ZX™-12R PARTS DIAGRAM

Brake Pedal/Torque Link

F2260

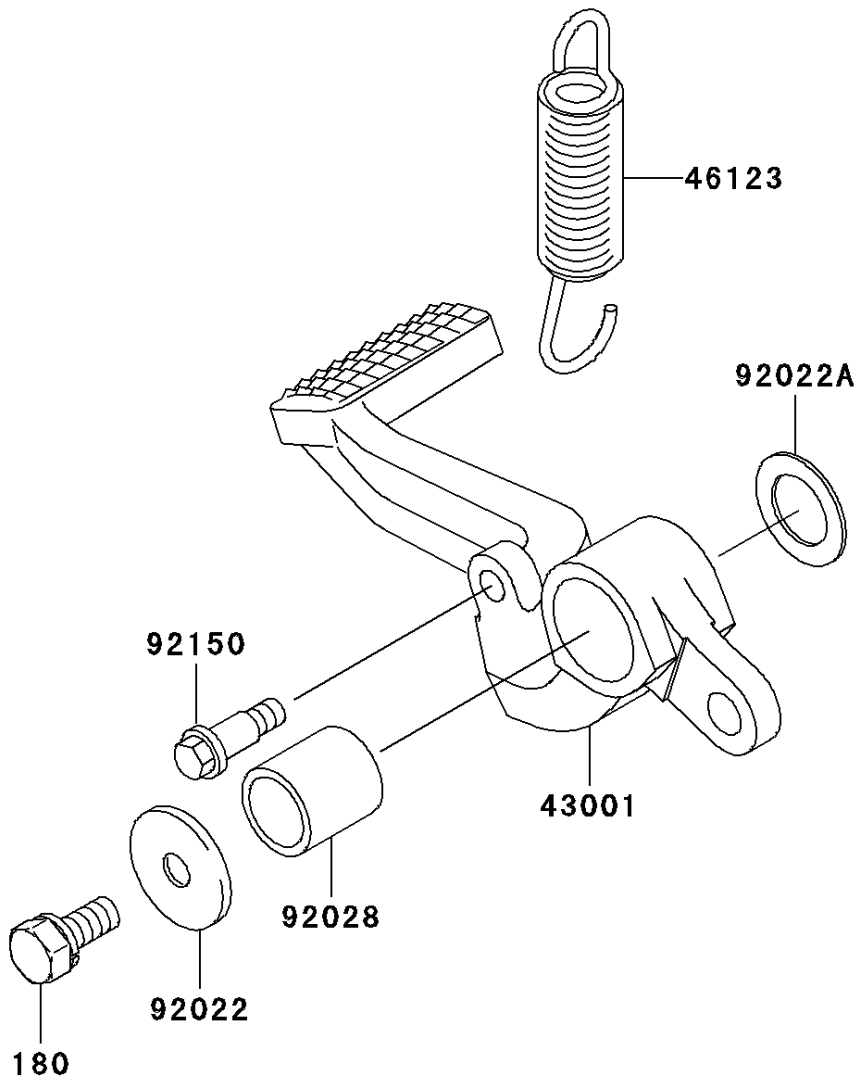

2003 Ninja® ZX™ -12R PARTS LIST

Brake Pedal/Torque Link

ITEM NAME	PART NUMBER	QUANTITY
BOLT-UPSET-WS (Ref # 180)	180H0614	1
LEVER-BRAKE,PEDAL (Ref # 43001)	43001-1421	1
SPRING-COMP,BRAKE PEDAL RETURN (Ref # 46123)	46123-1058	1
WASHER,7X28X1.6 (Ref # 92022)	92022-1282	1
WASHER,15.3X24X1 (Ref # 92022A)	92022-326	1
BUSHING,BRAKE PEDAL (Ref # 92028)	92028-1282	1
BOLT,6MM (Ref # 92150)	92150-1113	1