

2025 NINJA® 650 PARTS DIAGRAM

Taillight(s)

F2720

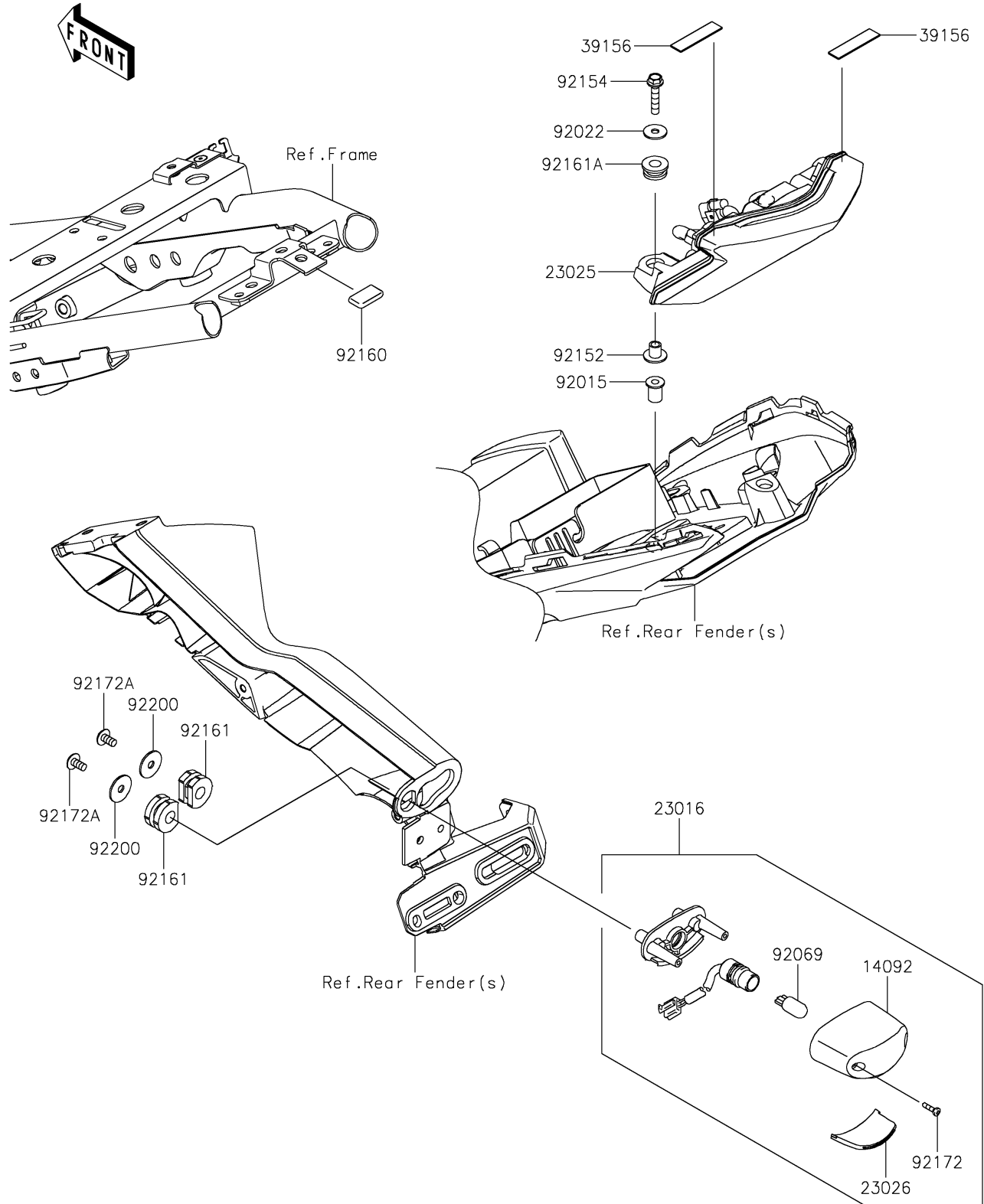

2025 NINJA® 650 PARTS LIST

Taillight(s)

| ITEM NAME | PART NUMBER | QUANTITY |
|------------------------------------|-------------|----------|
| COVER,LICENSE LAMP (Ref # 14092) | 14092-0001 | 1 |
| LAMP-ASSY,LICENSE (Ref # 23016) | 23016-0656 | 1 |
| LAMP-TAIL,LED (Ref # 23025) | 23025-0362 | 1 |
| LENS,LICENCE LAMP (Ref # 23026) | 23026-0035 | 1 |
| PAD,40X10X1 (Ref # 39156) | 39156-2595 | 2 |
| NUT,WELL,5MM (Ref # 92015) | 92015-1757 | 2 |
| WASHER,5.2X16X1.2 (Ref # 92022) | 92022-263 | 2 |
| BULB,12V 5W (Ref # 92069) | 92069-1016 | 1 |
| COLLAR,5.6X8X11.2 (Ref # 92152) | 92152-1562 | 2 |
| BOLT,FLANGED,5X25 (Ref # 92154) | 92154-0846 | 2 |
| DAMPER (Ref # 92160) | 92160-1190 | 1 |
| DAMPER (Ref # 92161) | 92161-0776 | 2 |
| DAMPER,8X18X8.1 (Ref # 92161A) | 92161-1369 | 2 |
| SCREW,TAPPING,2.9X13 (Ref # 92172) | 92172-0343 | 2 |
| SCREW,TAPPING,5X16 (Ref # 92172A) | 92172-0427 | 2 |
| WASHER,5.5X20X1.2 (Ref # 92200) | 92200-0284 | 2 |