

2004 ZZR1200 PARTS DIAGRAM

Breather Cover/Oil Pan

E1432

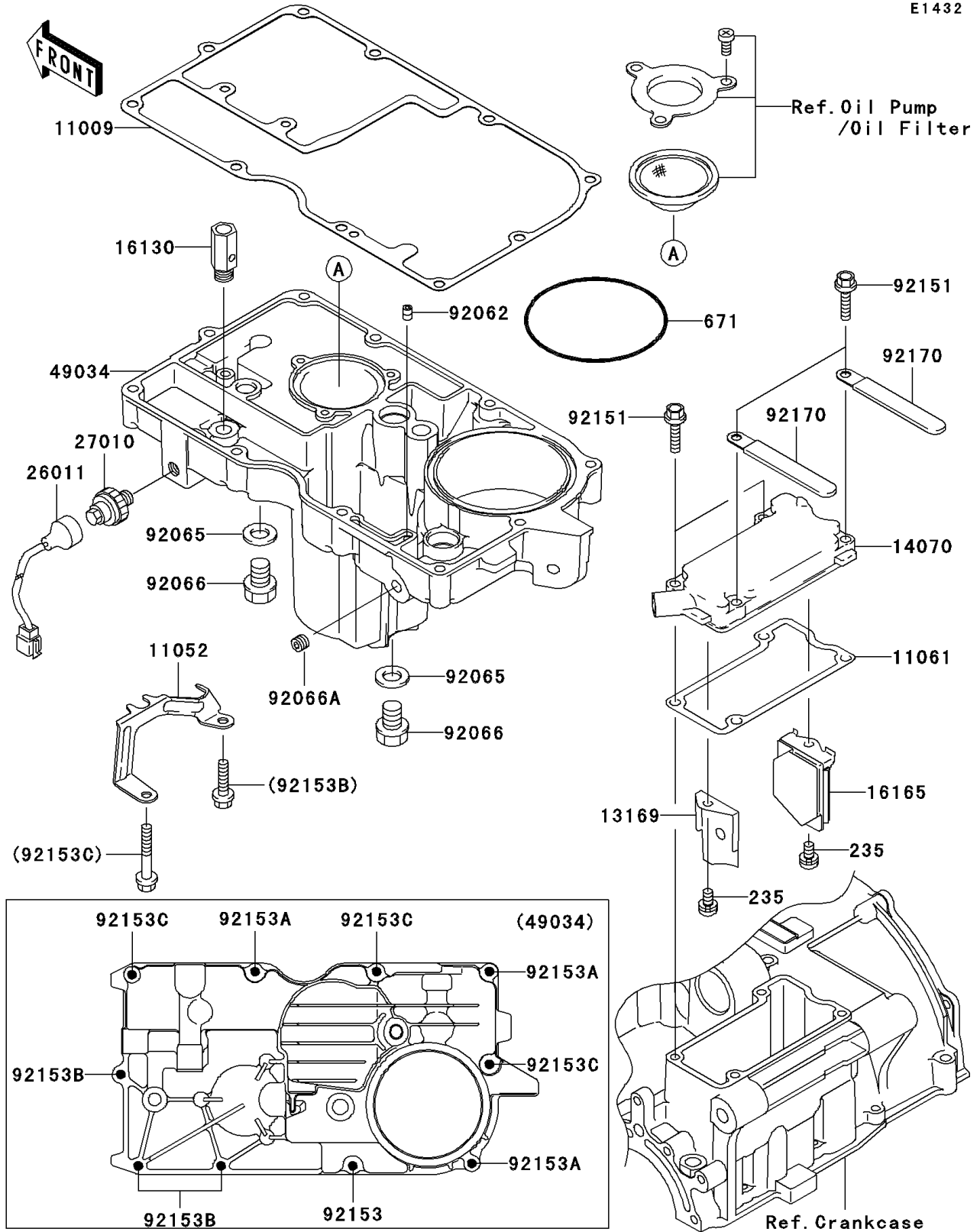

2004 ZZR1200 PARTS LIST

Breather Cover/Oil Pan

ITEM NAME	PART NUMBER	QUANTITY
SCREW-PAN-WP-CROS (Ref # 235)	235B0610	2
O RING,90MM (Ref # 671)	671B2590	1
GASKET,OIL PAN (Ref # 11009)	11009-1981	1
BRACKET (Ref # 11052)	11052-1961	1
GASKET,BREATHER BODY (Ref # 11061)	11061-1102	1
PLATE,BREATHER (Ref # 13169)	13169-1967	1
BODY-BREATHER (Ref # 14070)	14070-1086	1
VALVE-ASSY-RELIEF (Ref # 16130)	16130-1058	1
SEPARATOR,OIL (Ref # 16165)	16165-1053	1
WIRE-LEAD,OIL PRESSURE (Ref # 26011)	26011-1811	1
SWITCH,OIL PRESSURE (Ref # 27010)	27010-1313	1
PAN-OIL (Ref # 49034)	49034-1145	1
NOZZLE,6X8,BLACK (Ref # 92062)	92062-1079	1
GASKET,12X22X2 (Ref # 92065)	92065-097	2
PLUG,OIL DRAIN,12X15 (Ref # 92066)	92066-1174	2
PLUG,PT1/8X7 (Ref # 92066A)	92066-1342	1
BOLT,6X25 (Ref # 92151)	92151-1546	4
BOLT,6X25 (Ref # 92153)	92153-1054	1
BOLT,6X40 (Ref # 92153A)	92153-1055	3
BOLT,6X25 (Ref # 92153B)	92153-1071	3
BOLT,6X40 (Ref # 92153C)	92153-1072	3
CLAMP (Ref # 92170)	92170-1925	2