

2025 Ultra 310LX PARTS DIAGRAM

Throttle

E1510

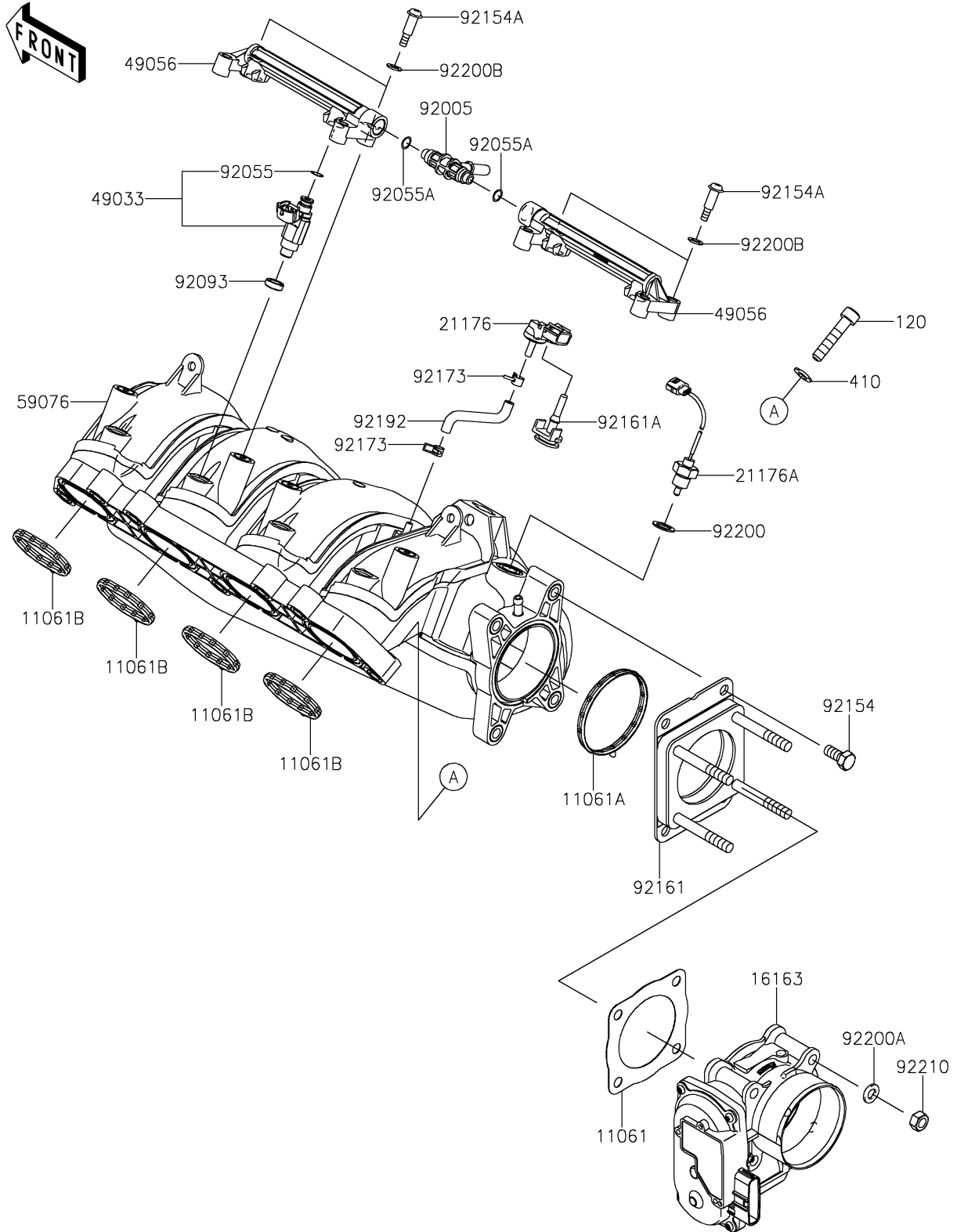

2025 Ultra 310LX PARTS LIST

Throttle

ITEM NAME	PART NUMBER	QUANTITY
GASKET,THROTTLE (Ref # 11061)	11061-0824	1
GASKET,MANIFOLD (Ref # 11061A)	11061-3766	1
GASKET,THROTTLE (Ref # 11061B)	11061-3767	4
THROTTLE-ASSY (Ref # 16163)	16163-1168	1
SENSOR,PRESSURE (Ref # 21176)	21176-0937	1
SENSOR,AIR TEMPERATURE (Ref # 21176A)	21176-3767	1
NOZZLE-INJECTION (Ref # 49033)	49033-3709	4
PIPE-INJECTION,FUEL (Ref # 49056)	49056-3705	2
MANIFOLD-INTAKE (Ref # 59076)	59076-0006	1
FITTING,FUEL PIPE (Ref # 92005)	92005-3766	1
RING-O,INJECTION NOZZLE (Ref # 92055)	92055-1622	4
RING-O (Ref # 92055A)	92055-3782	2
SEAL (Ref # 92093)	92093-0127	4
BOLT (Ref # 92154)	92154-1389	4
BOLT (Ref # 92154A)	92154-3713	4
DAMPER (Ref # 92161)	92161-1635	1
DAMPER (Ref # 92161A)	92161-3796	1
CLAMP (Ref # 92173)	92173-3702	2
TUBE (Ref # 92192)	92192-1361	1
WASHER,12X18X1 (Ref # 92200)	92200-0712	1
WASHER (Ref # 92200A)	92200-3806	4
WASHER (Ref # 92200B)	92200-3807	4
NUT (Ref # 92210)	92210-0897	4
BOLT-SOCKET,8X40 (Ref # 120)	120CC0840	7
WASHER-PLAIN-SMALL,8MM (Ref # 410)	410S0800	7