

2025 Ultra 310LX PARTS DIAGRAM

Seat

F3146

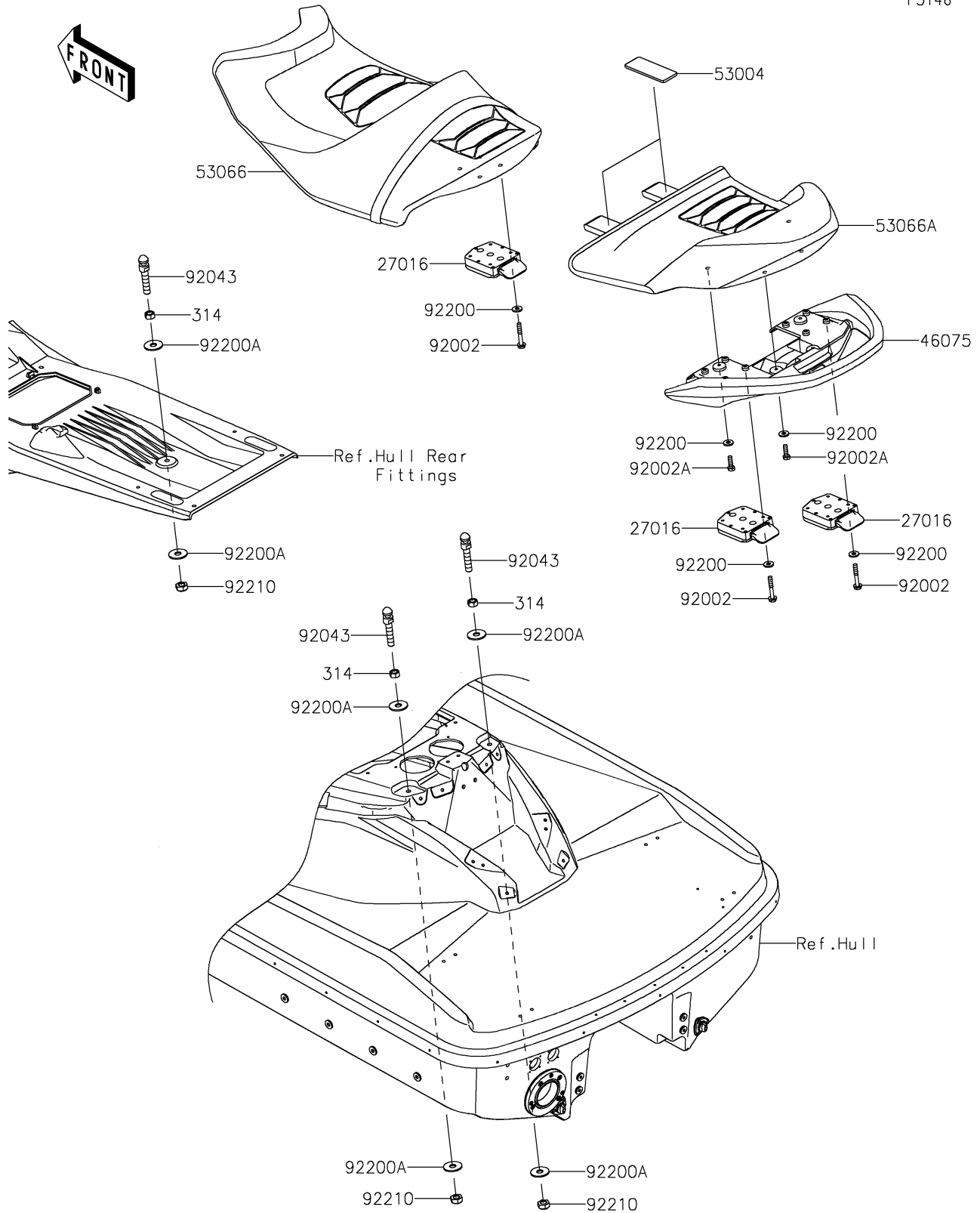

2025 Ultra 310LX PARTS LIST

Seat

ITEM NAME	PART NUMBER	QUANTITY
LOCK-ASSY,SEAT,FR&RR (Ref # 27016)	27016-0099	3
GRIP,RR (Ref # 46075)	46075-0656	1
MAT,50X135X6 (Ref # 53004)	53004-0694	2
SEAT-ASSY,FR,BLACK+BRN+SIL+SIL (Ref # 53066)	53066-0803-73J	1
SEAT-ASSY,RR,BLACK+BRN+SIL (Ref # 53066A)	53066-0806-73K	1
BOLT,6X40 (Ref # 92002)	92002-3716	12
BOLT,6X20 (Ref # 92002A)	92002-3755	4
PIN (Ref # 92043)	92043-3763	3
WASHER,6.5X16X2.0 (Ref # 92200)	92200-1543	16
WASHER (Ref # 92200A)	92200-3762	6
NUT,LOCK,10MM (Ref # 92210)	92210-3792	3
NUT-HEX-FINE,10MM (Ref # 314)	314R1000	3