

# 2024 MULE™ 4010 TRANS4x4® PARTS DIAGRAM

## Cylinder Head

E1111

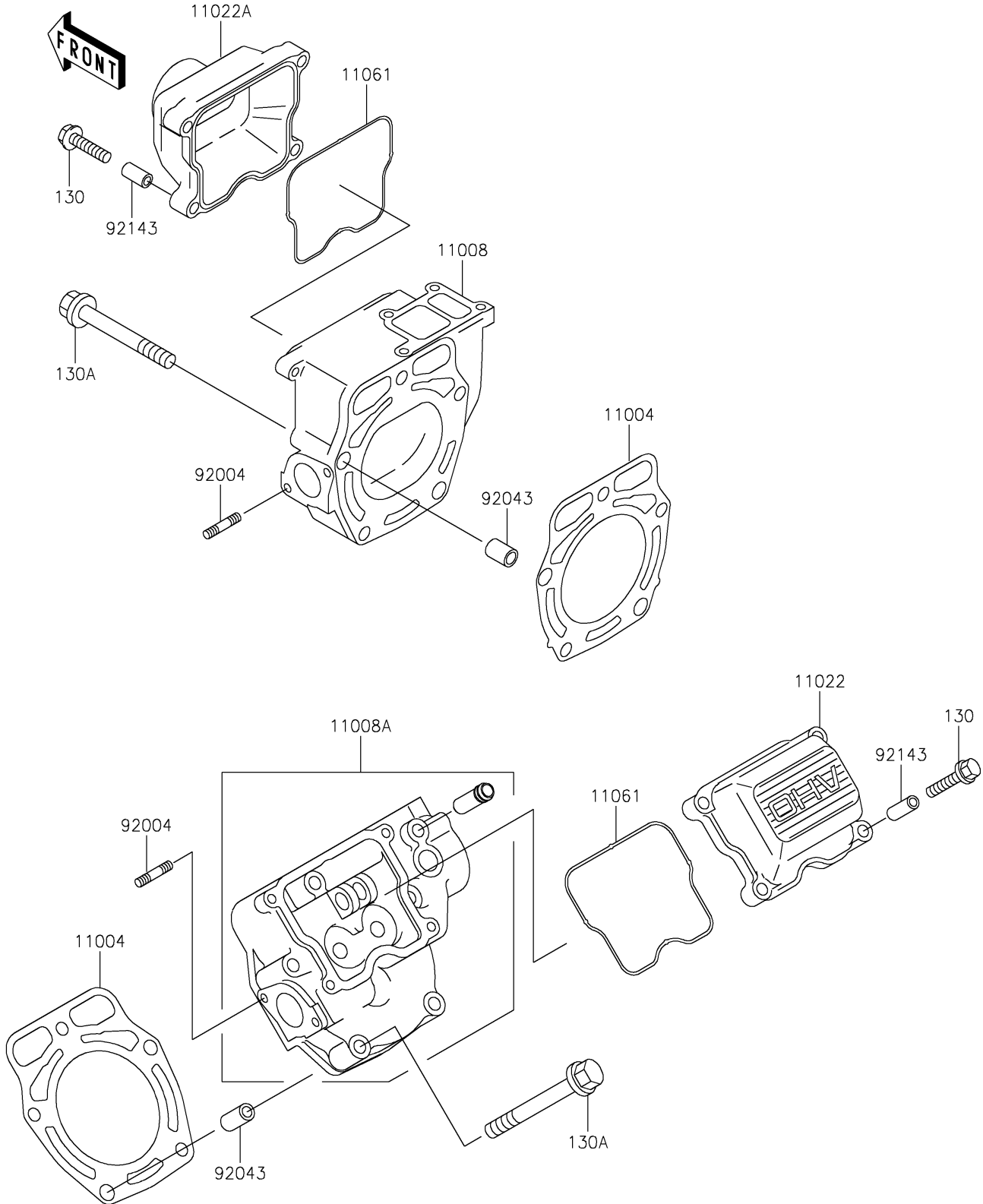

## 2024 MULE™ 4010 TRANS4x4® PARTS LIST

### Cylinder Head

ITEM NAME	PART NUMBER	QUANTITY
GASKET-HEAD (Ref # 11004)	11004-2107	2
HEAD-COMP-CYLINDER,#1 (Ref # 11008)	11008-0820	1
HEAD-COMP-CYLINDER,#2 (Ref # 11008A)	11008-6046	1
CASE-ROCKER (Ref # 11022)	11022-2056	1
CASE-ROCKER (Ref # 11022A)	11022-2068	1
GASKET,ROCKER CASE (Ref # 11061)	11061-2182	2
STUD,6X20 (Ref # 92004)	92004-2142	4
PIN,DOWEL,10X14 (Ref # 92043)	92043-1037	4
COLLAR (Ref # 92143)	92143-2010	8
BOLT-FLANGED,6X25 (Ref # 130)	130BA0625	8
BOLT-FLANGED,8X65 (Ref # 130A)	130BA0865	10