

2025 Vulcan S PARTS DIAGRAM

Turn Signals

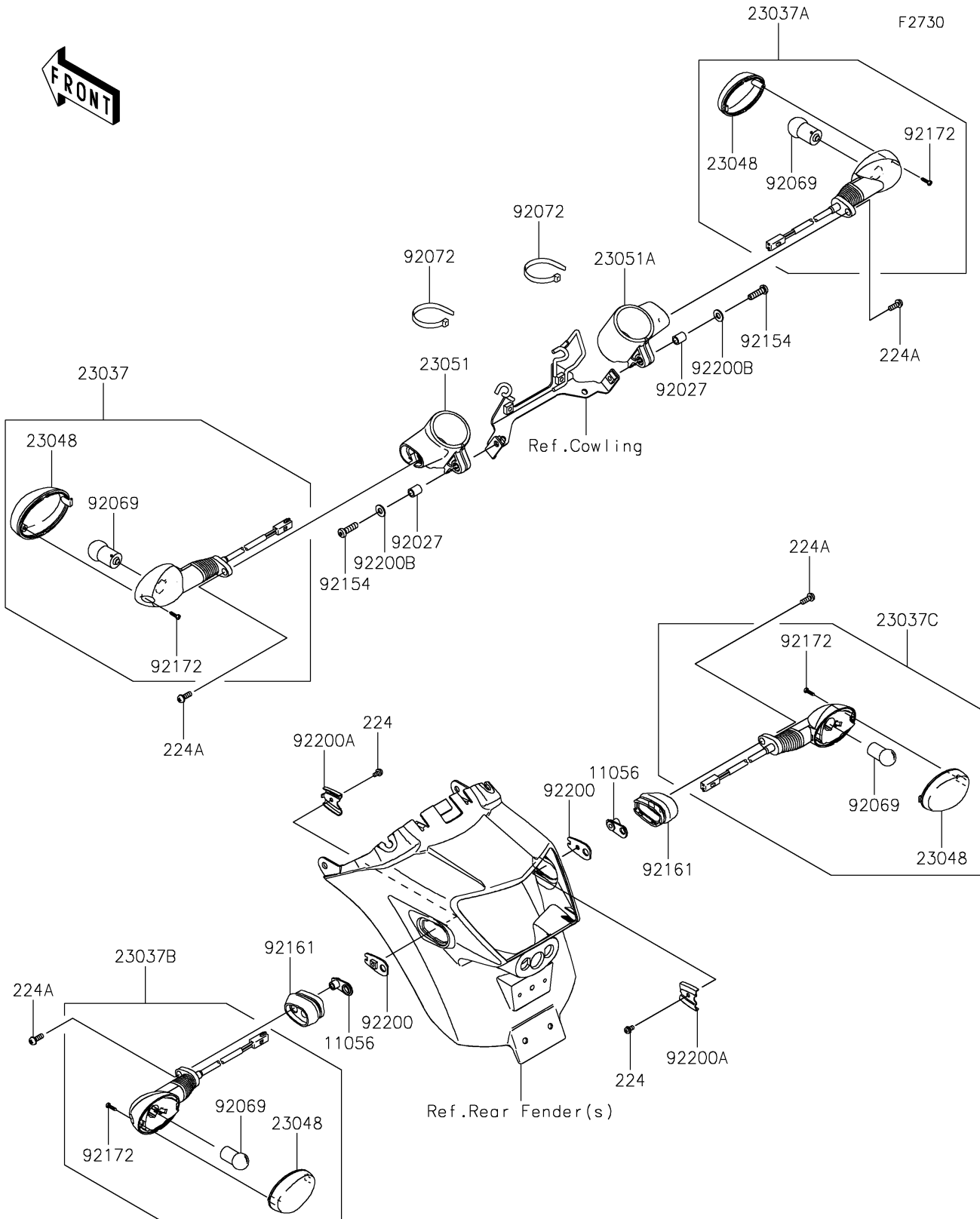

2025 Vulcan S PARTS LIST

Turn Signals

ITEM NAME	PART NUMBER	QUANTITY
BRACKET,6MM (Ref # 11056)	11056-4156	2
LAMP-ASSY-SIGNAL,FR,LH (Ref # 23037)	23037-0416	1
LAMP-ASSY-SIGNAL,FR,RH (Ref # 23037A)	23037-0417	1
LAMP-ASSY-SIGNAL,RR,LH (Ref # 23037B)	23037-0452	1
LAMP-ASSY-SIGNAL,RR,RH (Ref # 23037C)	23037-0453	1
LENS-SIGNAL LAMP (Ref # 23048)	23048-0035	4
BRACKET-SIGNAL LAMP,LH (Ref # 23051)	23051-0042	1
BRACKET-SIGNAL LAMP,RH (Ref # 23051A)	23051-0043	1
COLLAR,6.8X10X12 (Ref # 92027)	92027-162	2
BULB,12V 10W (Ref # 92069)	92069-0106	4
BAND,L=152 (Ref # 92072)	92072-3874	2
BOLT,SOCKET,6X22 (Ref # 92154)	92154-0402	2
DAMPER,SIGNAL LAMP (Ref # 92161)	92161-1680	2
SCREW,TAPPING,2.9X13 (Ref # 92172)	92172-0343	4
WASHER,SIGNAL LAMP (Ref # 92200)	92200-0164	2
WASHER,SIGNAL LAMP (Ref # 92200A)	92200-0165	2
WASHER,6.5X14X1.2 (Ref # 92200B)	92200-0964	2
SCREW-PAN-WP-CROS,4X8 (Ref # 224)	224AB0408	2
SCREW-PAN-WP-CROS,6X14 (Ref # 224A)	224AB0614	4