

2025 Z500 SE PARTS DIAGRAM

Water Pump

E3031

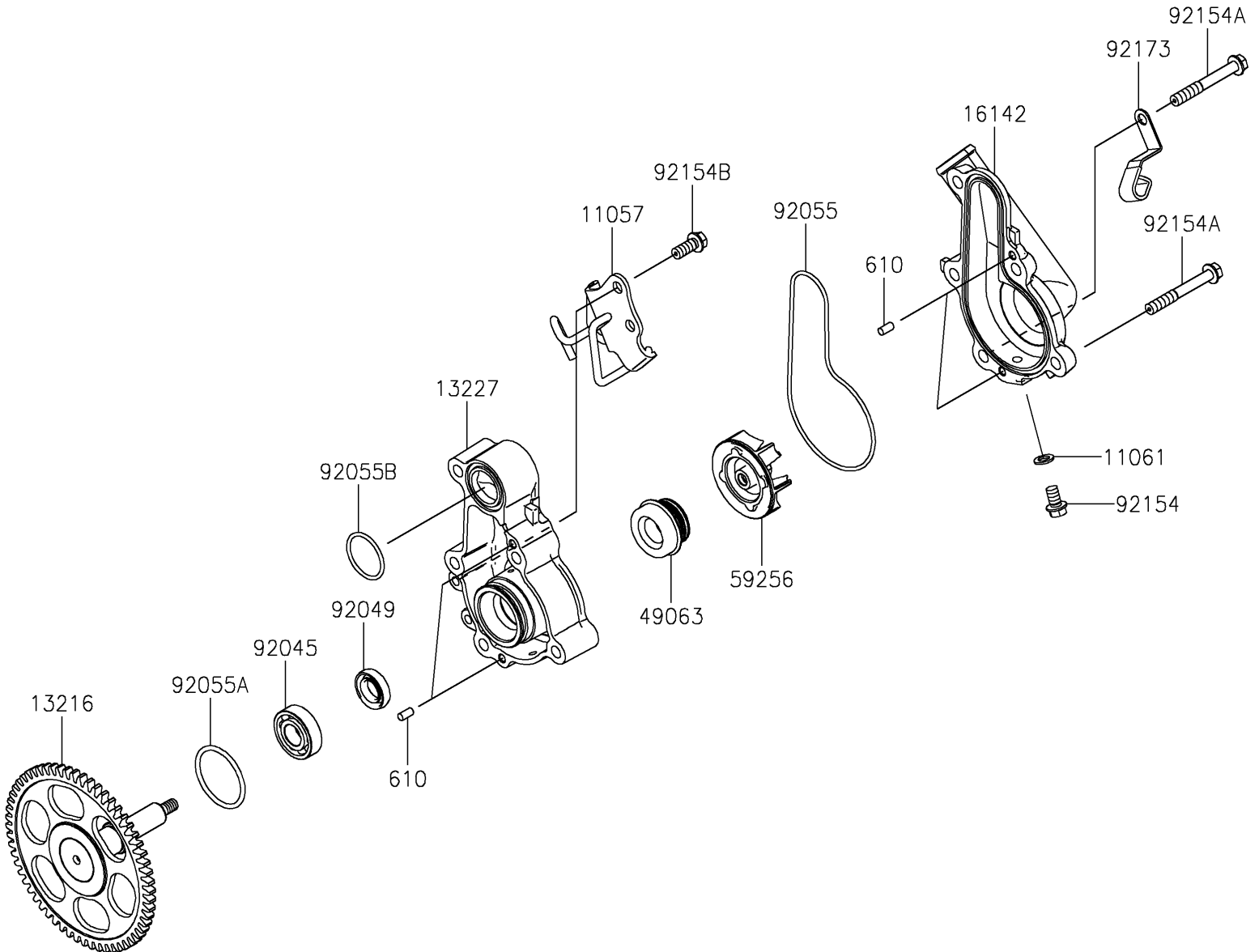

2025 Z500 SE PARTS LIST

Water Pump

ITEM NAME	PART NUMBER	QUANTITY
BRACKET, FIX COWL. (Ref # 11057)	11057-1834	1
GASKET, DRAIN (Ref # 11061)	11061-0875	1
GEAR-COMP, WATER PUMP, 60T (Ref # 13216)	13216-0920	1
HOUSING (Ref # 13227)	13227-0040	1
COVER-PUMP, WATER (Ref # 16142)	16142-0757	1
SEAL-MECHANICAL (Ref # 49063)	49063-1055	1
IMPELLER (Ref # 59256)	59256-0554	1
BEARING-BALL (Ref # 92045)	92045-0067	1
SEAL-OIL, 12X22X5 (Ref # 92049)	92049-0783	1
RING-O (Ref # 92055)	92055-0889	1
RING-O, 31.20X2.4 (Ref # 92055A)	92055-0896	1
RING-O, 23.3X1.9 (Ref # 92055B)	92055-1555	1
BOLT, FLANGED, 6X10 (Ref # 92154)	92154-2344	1
BOLT, FLANGED, 6X45 (Ref # 92154A)	92154-2789	5
BOLT, FLANGED, 6X14 (Ref # 92154B)	92154-2838	2
CLAMP (Ref # 92173)	92173-1935	1
ROLLER, 4X8 (Ref # 610)	610A0408	4