

2025 Z500 SE ABS PARTS DIAGRAM

Suspension/Shock Absorber

F2151

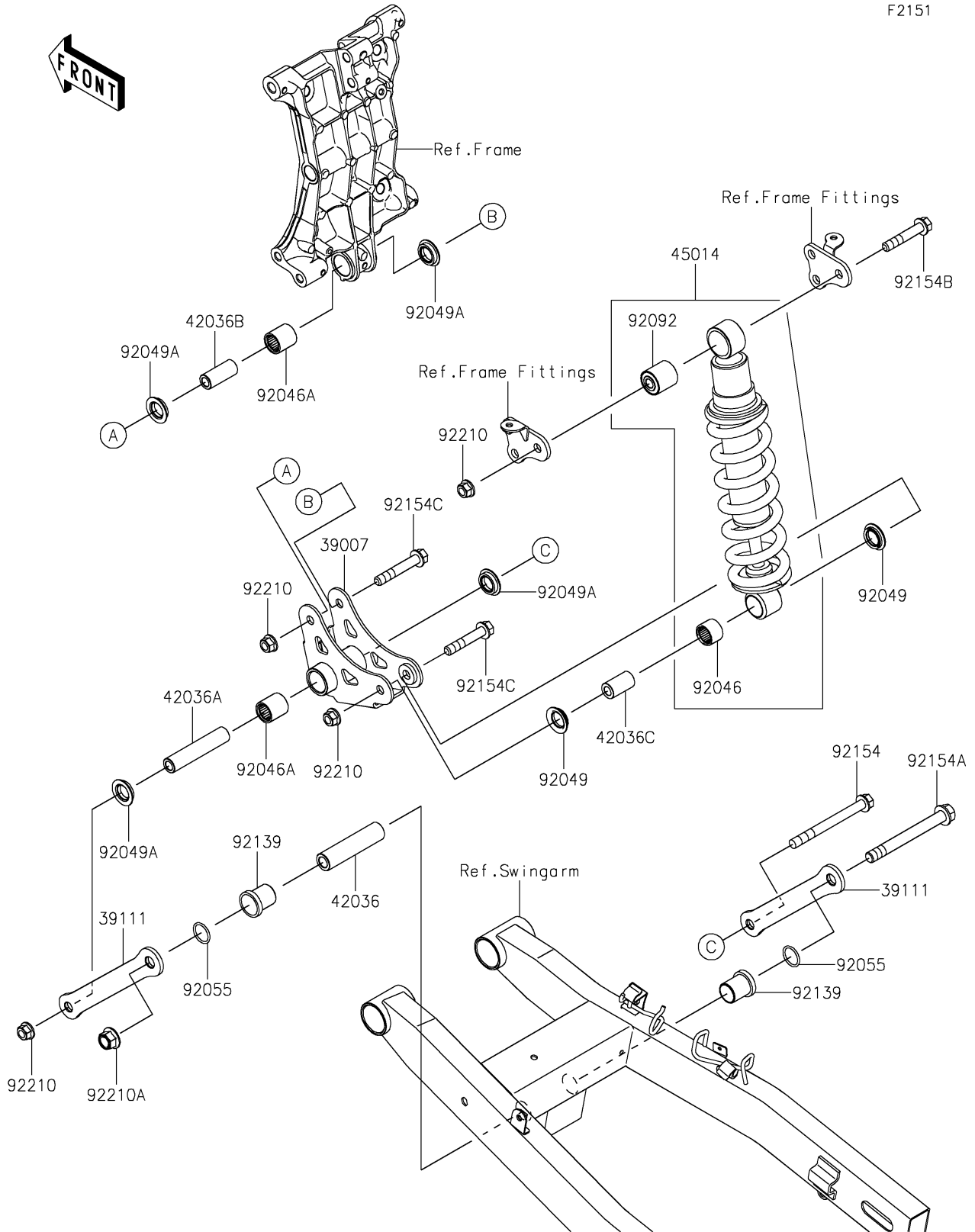

2025 Z500 SE ABS PARTS LIST

Suspension/Shock Absorber

ITEM NAME	PART NUMBER	QUANTITY
ARM-SUSP (Ref # 39007)	39007-0512	1
ROD-TIE,SUSPENSION (Ref # 39111)	39111-0365	2
SLEEVE,12.1X20X83 (Ref # 42036)	42036-0807	1
SLEEVE,10.1X17X83 (Ref # 42036A)	42036-0808	1
SLEEVE,10.1X17X40.5 (Ref # 42036B)	42036-0809	1
SLEEVE,10.1X18X32 (Ref # 42036C)	42036-1344	1
SHOCKABSORBER,BLACK+BLK (Ref # 45014)	45014-0619-37S	1
BEARING-NEEDLE,SFYZM182417 (Ref # 92046)	92046-1272	1
BEARING-NEEDLE,SFYZM172425 (Ref # 92046A)	92046-1273	2
SEAL-OIL (Ref # 92049)	92049-0133	2
SEAL-OIL,MHA17245.7F (Ref # 92049A)	92049-0850	4
RING-O,19.8X2.2 (Ref # 92055)	92055-1215	2
BUSHING-RUBBER (Ref # 92092)	92092-1058	1
BUSHING,20X23X29 (Ref # 92139)	92139-0890	2
BOLT,FLANGED,10X105 (Ref # 92154)	92154-2810	1
BOLT,FLANGED,12X110 (Ref # 92154A)	92154-2811	1
BOLT,FLANGED,10X54 (Ref # 92154B)	92154-2813	1
BOLT,FLANGED,10X60 (Ref # 92154C)	92154-3771	2
NUT,LOCK,FLANGED,10MM (Ref # 92210)	92210-1139	4
NUT,LOCK,FLANGED,12MM (Ref # 92210A)	92210-1150	1