

1995 Ninja® 600R PARTS DIAGRAM

Generator

E1810-0137

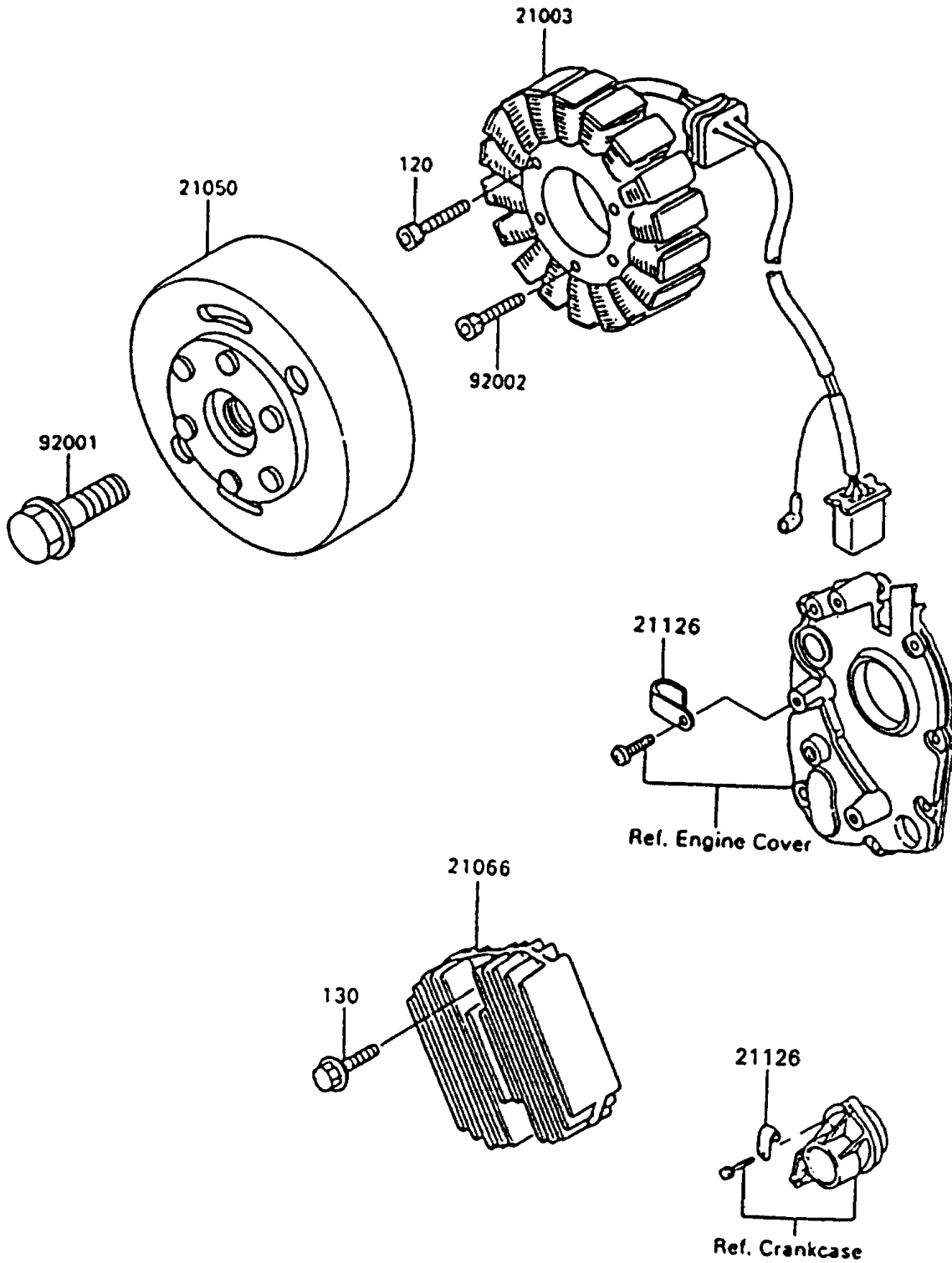

1995 Ninja® 600R PARTS LIST

Generator

ITEM NAME	PART NUMBER	QUANTITY
STATOR (Ref # 21003)	21003-1124	1
FLYWHEEL (Ref # 21050)	21050-1111	1
REGULATOR-VOLTAGE (Ref # 21066)	21066-1089	1
CLAMP,WIRING HARNESS (Ref # 21126)	21126-008	2
BOLT,FLANGED,12X40 (Ref # 92001)	92001-1146	1
BOLT,6X28 (Ref # 92002)	92002-1537	1
BOLT-SOCKET,6X28 (Ref # 120)	120P0628	2
BOLT-FLANGED (Ref # 130)	130H0620	2