

# 2022 TERYX KRX® 1000 PARTS DIAGRAM

Drive Converter

E1391

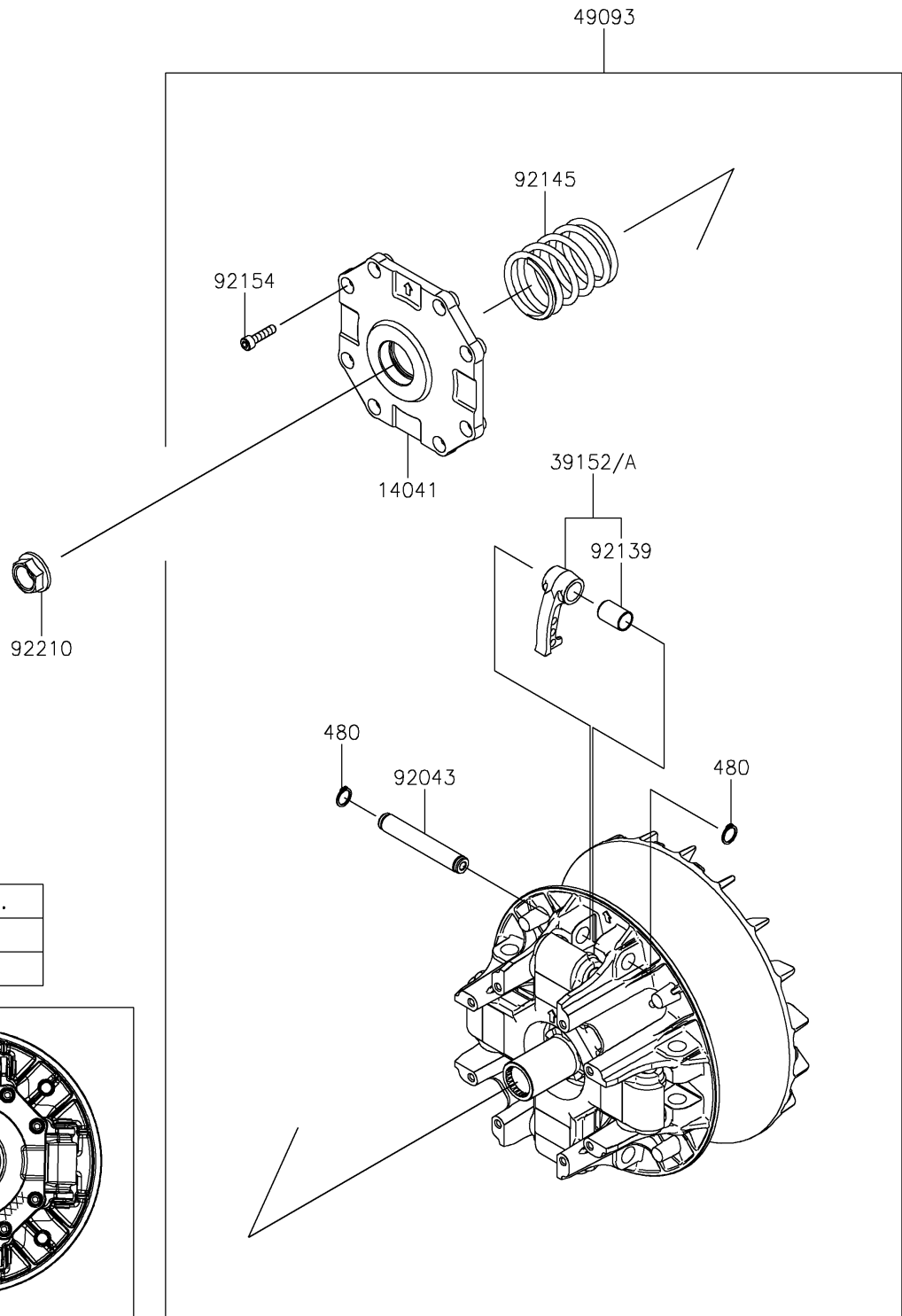

Mark	Ref No.
75 or 77	39152
Other	39152A

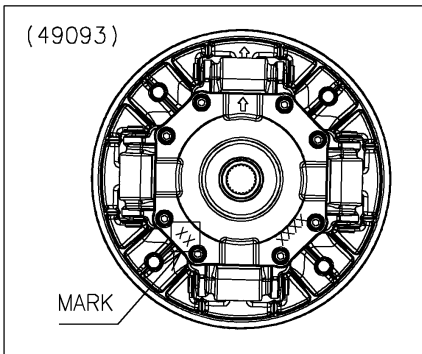

## 2022 TERYX KRX® 1000 PARTS LIST

### Drive Converter

ITEM NAME	PART NUMBER	QUANTITY
COVER-COMP (Ref # 14041)	14041-0622	1
WEIGHT-RAMP (Ref # 39152)	39152-0048	4
WEIGHT-RAMP (Ref # 39152A)	39152-0097	4
CONVERTER-ASSY-DRIVE (Ref # 49093)	49093-0077	1
PIN (Ref # 92043)	92043-1747	4
BUSHING (Ref # 92139)	92139-0933	4
SPRING (Ref # 92145)	92145-1855	1
BOLT-SOCKET,6X25 (Ref # 92154)	92154-3960	8
NUT,20MM (Ref # 92210)	92210-1753	1
CIRCLIP-TYPE-C,13MM (Ref # 480)	480J1300	8