

2022 TERYX KRX® 1000 PARTS DIAGRAM

Steering Shaft

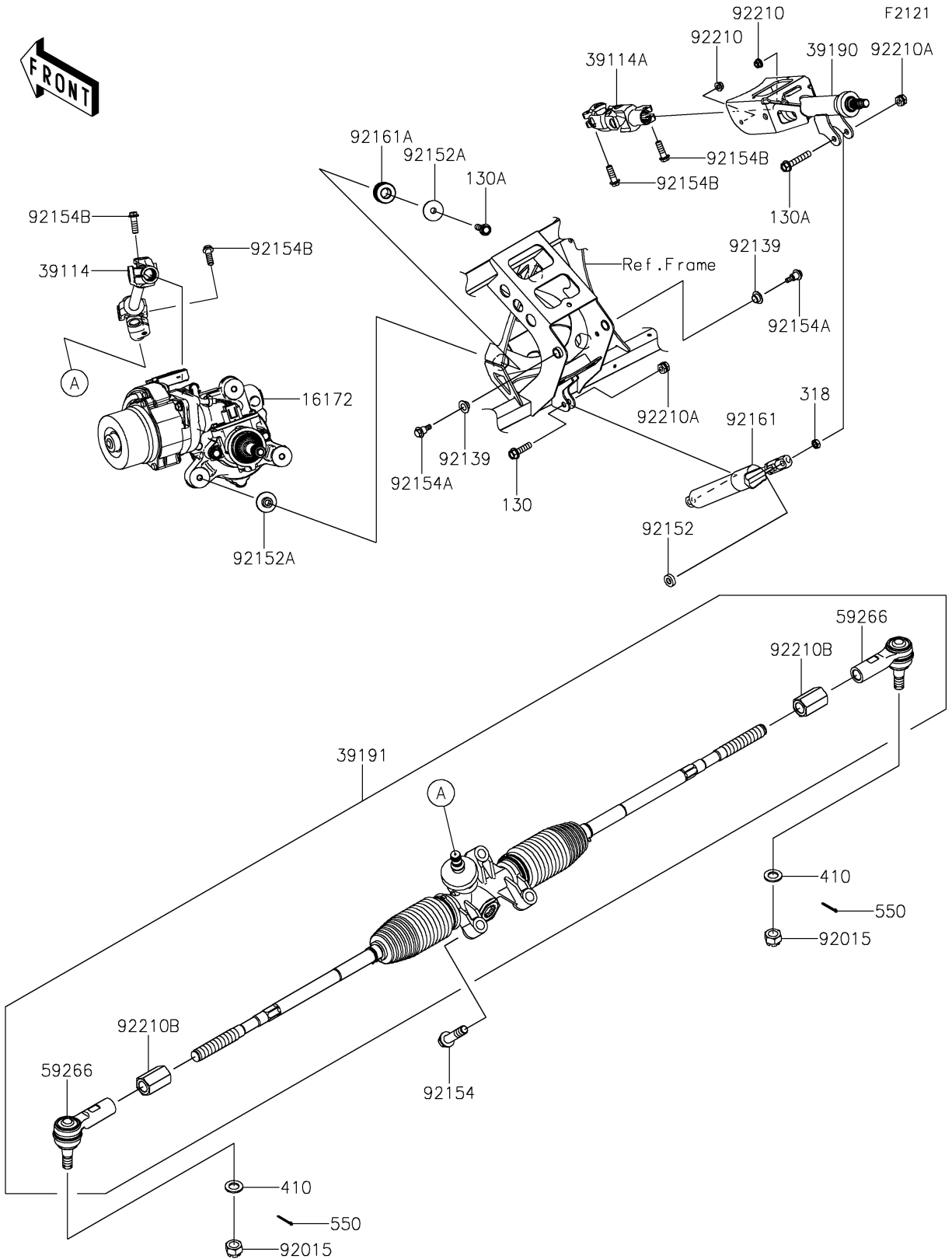

2022 TERYX KRX® 1000 PARTS LIST

Steering Shaft

| ITEM NAME | PART NUMBER | QUANTITY |
|---------------------------------------|-------------|----------|
| ACTUATOR, EPS (Ref # 16172) | 16172-0043 | 1 |
| SHAFT-COMP-STRG, LWR (Ref # 39114) | 39114-0023 | 1 |
| SHAFT-COMP-STRG, UPP (Ref # 39114A) | 39114-0024 | 1 |
| SHAFT-ASSY-STEERING (Ref # 39190) | 39190-0009 | 1 |
| GEAR-ASSY-STEERING (Ref # 39191) | 39191-0034 | 1 |
| JOINT-BALL (Ref # 59266) | 59266-0743 | 2 |
| NUT, CASTLE, 14MM (Ref # 92015) | 92015-1841 | 2 |
| BUSHING (Ref # 92139) | 92139-0230 | 2 |
| COLLAR, 8.2X18X5 (Ref # 92152) | 92152-1848 | 1 |
| COLLAR, 8.5X30X10.6 (Ref # 92152A) | 92152-2149 | 6 |
| BOLT, FLANGED, 12X50 (Ref # 92154) | 92154-1008 | 3 |
| BOLT, 6X21.5 (Ref # 92154A) | 92154-1320 | 2 |
| BOLT, FLANGED, 8X25 (Ref # 92154B) | 92154-2190 | 4 |
| DAMPER, STEERING TILT (Ref # 92161) | 92161-2186 | 1 |
| DAMPER (Ref # 92161A) | 92161-2187 | 3 |
| NUT, LOCK, FLANGED, 6MM (Ref # 92210) | 92210-0303 | 2 |
| NUT, HARD LOCK, 8MM (Ref # 92210A) | 92210-0934 | 2 |
| NUT (Ref # 92210B) | 92210-1803 | 2 |
| BOLT-FLANGED, 8X30 (Ref # 130) | 130CA0830 | 1 |
| BOLT-FLANGED, 8X45 (Ref # 130A) | 130CA0845 | 4 |
| NUT-HEX-SMALL, 8MM (Ref # 318) | 318BA0800 | 1 |
| WASHER-PLAIN-SMALL, 14MM (Ref # 410) | 410AA1400 | 2 |
| PIN-COTTER, 3.0X25 (Ref # 550) | 550AA3025 | 2 |