

1991 Ninja® ZX™-6 PARTS DIAGRAM

Oil Pan

E1434

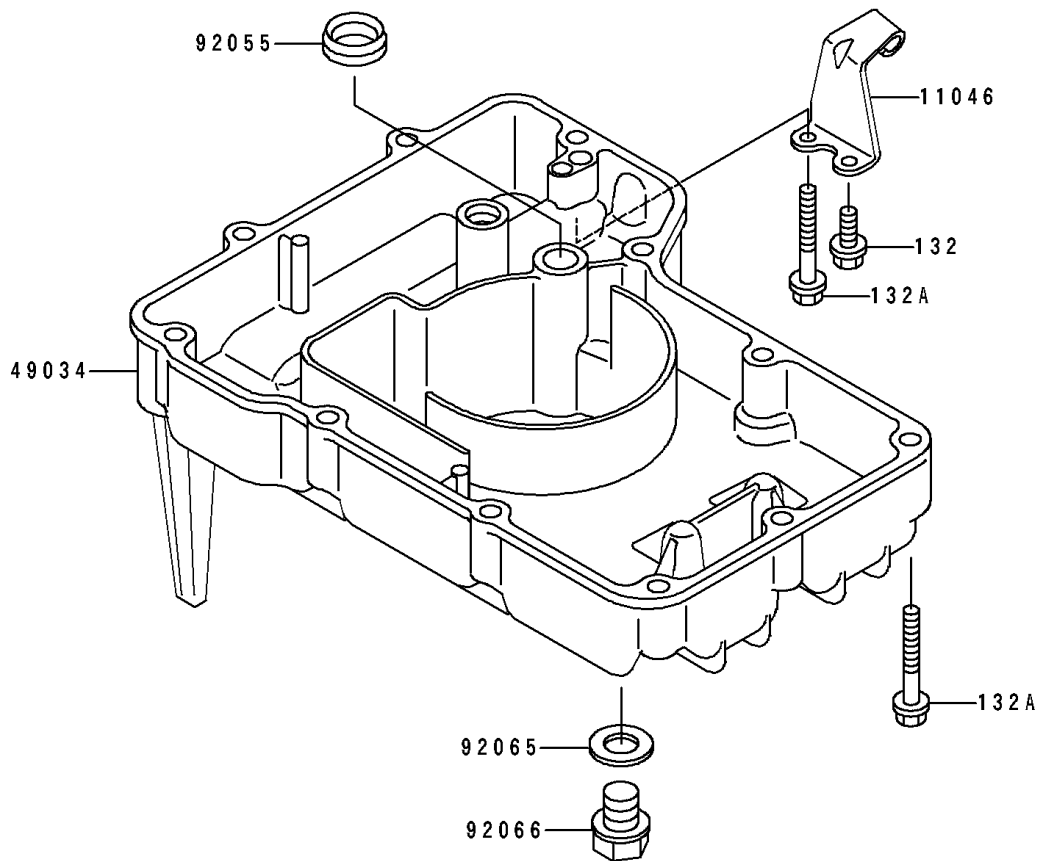
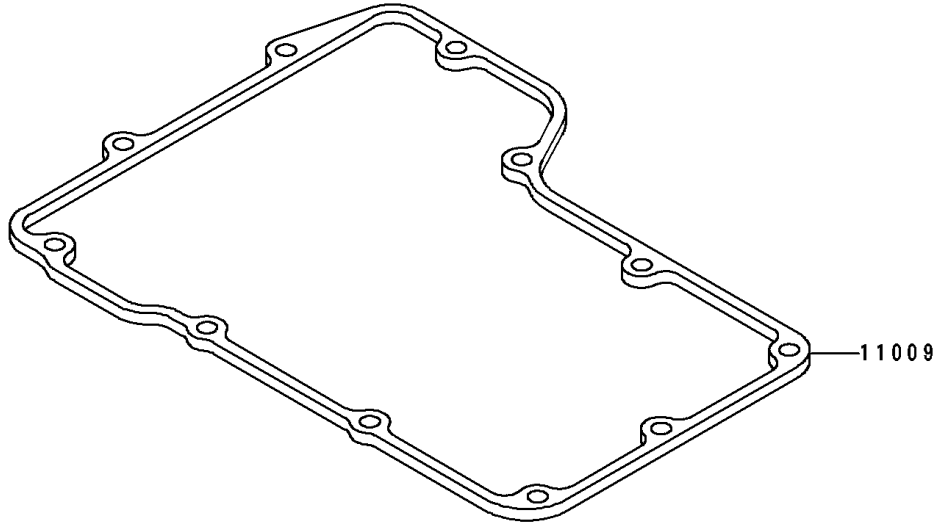

1991 Ninja® ZX™ -6 PARTS LIST

Oil Pan

ITEM NAME	PART NUMBER	QUANTITY
GASKET,OIL PAN (Ref # 11009)	11009-1870	1
BRACKET,CLUTCH WIRE (Ref # 11046)	11046-1912	1
PAN-OIL (Ref # 49034)	49034-1090	1
RING-O,OD=18 (Ref # 92055)	92055-048	1
GASKET,12X22X2,DRAIN PLUG (Ref # 92065)	92065-097	1
PLUG,OIL DRAIN,12X15 (Ref # 92066)	92066-1174	1
BOLT-FLANGED-SMALL (Ref # 132)	132G0612	1
BOLT-FLANGED-SMALL (Ref # 132A)	132G0640	11