

2024 TERYX KRX® 1000 eS PARTS DIAGRAM

Muffler(s)

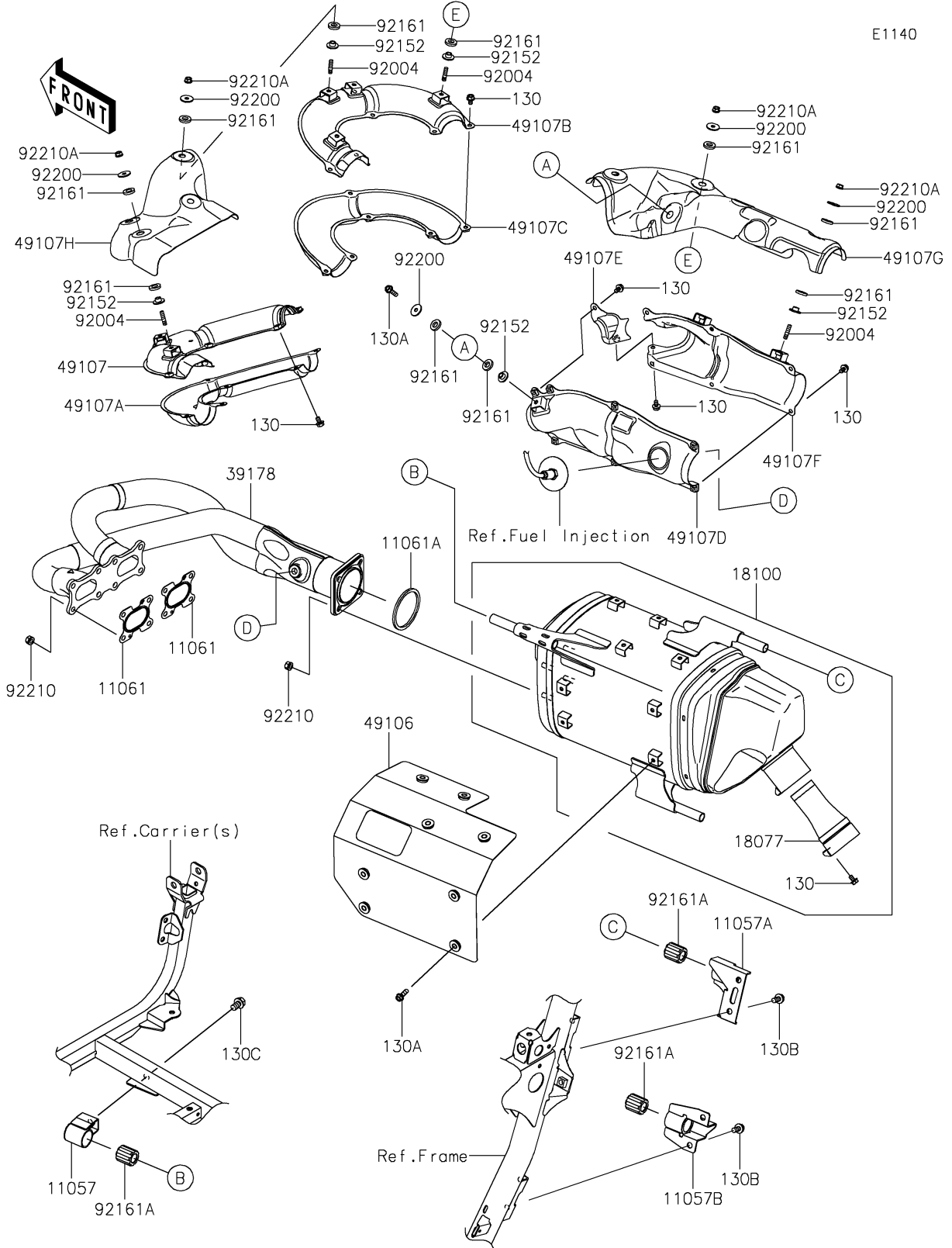

2024 TERYX KRX® 1000 eS PARTS LIST

Muffler(s)

ITEM NAME	PART NUMBER	QUANTITY
BRACKET,FRM-MUFFLER/FR (Ref # 11057)	11057-3721	1
BRACKET,FRM-MUFFLER/RR/UPP (Ref # 11057A)	11057-3722	1
BRACKET,FRM-MUFFLER/RR/LWR (Ref # 11057B)	11057-3723	1
GASKET,CYL.HEAD-EXHAUST PIPE (Ref # 11061)	11061-1310	2
GASKET,EXHAUST PIPE-MUFFLER (Ref # 11061A)	11061-1311	1
ARRESTER-SPARK (Ref # 18077)	18077-0045	1
BODY-ASSY-MUFFLER (Ref # 18100)	18100-0613	1
MANIFOLD-COMP-EXHAUST (Ref # 39178)	39178-0389	1
COVER-MUFFLER (Ref # 49106)	49106-0847	1
COVER-EXHAUST PIPE,#1,UPP (Ref # 49107)	49107-0814	1
COVER-EXHAUST PIPE,#1,LWR (Ref # 49107A)	49107-0815	1
COVER-EXHAUST PIPE,#2,UPP (Ref # 49107B)	49107-0816	1
COVER-EXHAUST PIPE,#2,LWR (Ref # 49107C)	49107-0817	1
COVER-EXHAUST PIPE,LH (Ref # 49107D)	49107-0819	1
COVER-EXHAUST PIPE (Ref # 49107E)	49107-0820	1
COVER-EXHAUST PIPE,RH (Ref # 49107F)	49107-0825	1
COVER-EXHAUST PIPE (Ref # 49107G)	49107-0829	1
COVER-EXHAUST PIPE (Ref # 49107H)	49107-0836	1
STUD,6X18 (Ref # 92004)	92004-0799	8
COLLAR (Ref # 92152)	92152-0423	9
DAMPER (Ref # 92161)	92161-0319	18
DAMPER (Ref # 92161A)	92161-2274	3
WASHER,6.5X22X1.6 (Ref # 92200)	92200-2324	9
NUT,8MM (Ref # 92210)	92210-1242	12
NUT,6MM (Ref # 92210A)	92210-1787	8
BOLT-FLANGED,6X10 (Ref # 130)	130BD0610	21
BOLT-FLANGED,6X20 (Ref # 130A)	130BD0620	9
BOLT-FLANGED,8X16 (Ref # 130B)	130CA0816	4
BOLT-FLANGED,10X16 (Ref # 130C)	130CA1016	1