

# 1991 Ninja® ZX™-6 PARTS DIAGRAM

Frame

F2120

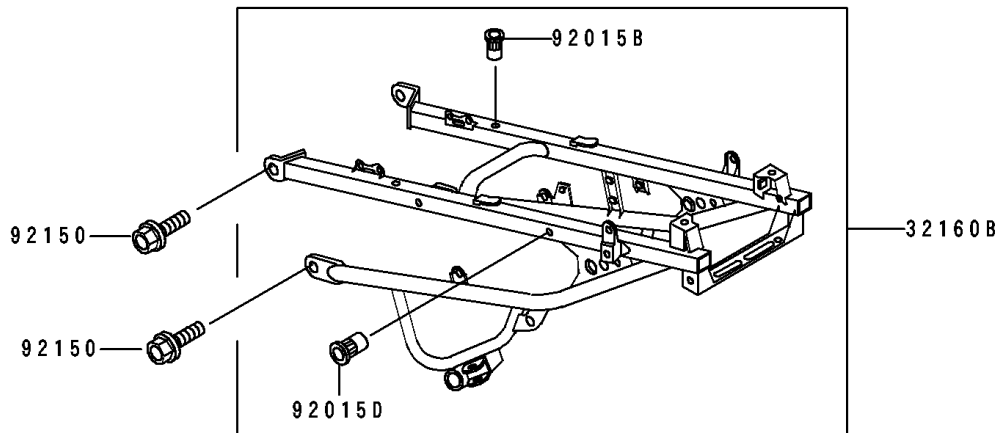
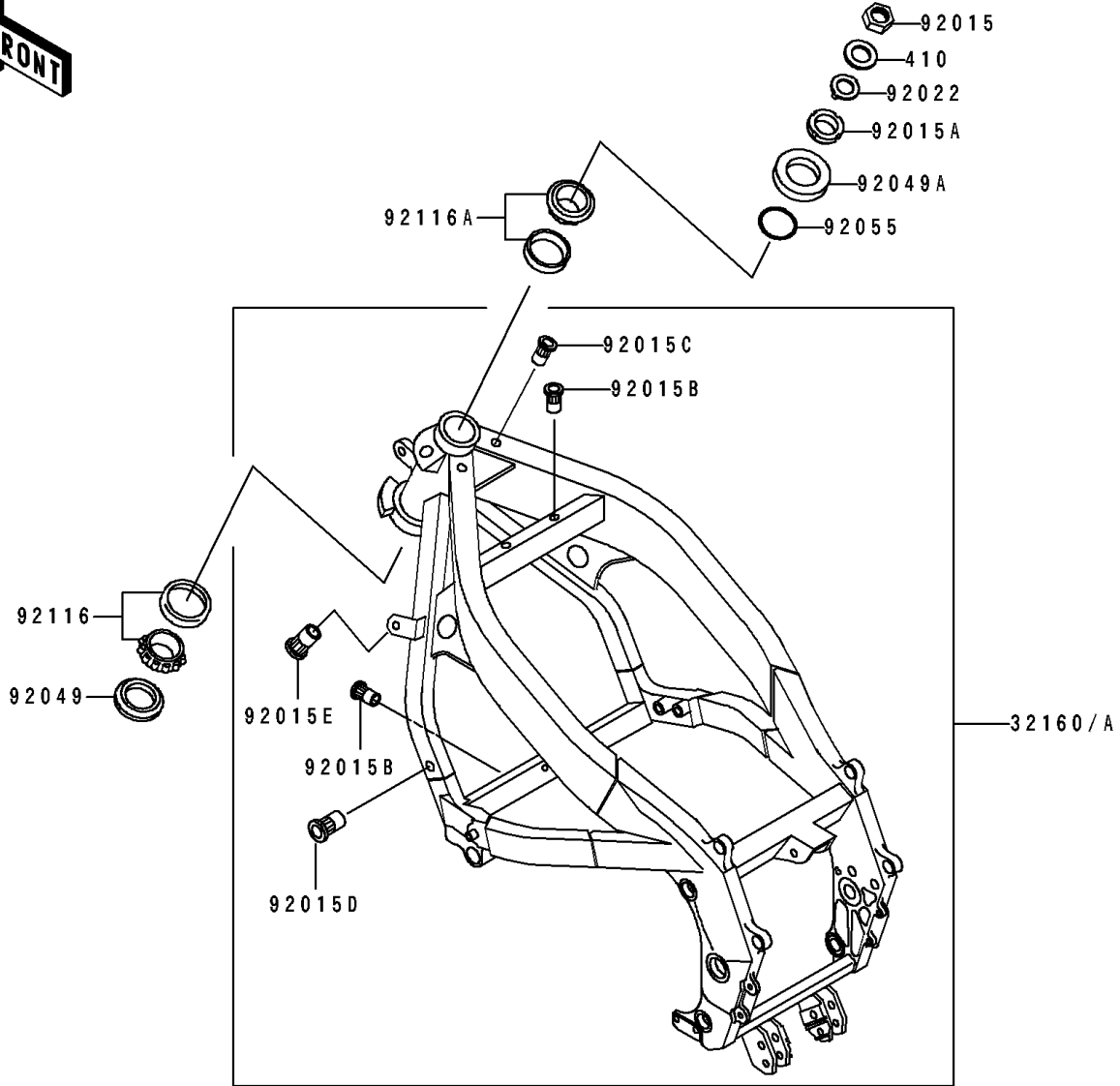

# 1991 Ninja® ZX™ -6 PARTS LIST

## Frame

ITEM NAME	PART NUMBER	QUANTITY
FRAME-COMP,FR,G.GRAY (Ref # 32160)	32160-1118-GD	1
FRAME-COMP,FR,G.GRAY (Ref # 32160A)	32160-1118-HN	1
FRAME-COMP,RR,BLACK (Ref # 32160B)	32160-1120-10	1
NUT,18MM (Ref # 92015)	92015-1404	1
NUT,25MM,T=12 (Ref # 92015A)	92015-1546	1
NUT,POP,6MM,L=15 (Ref # 92015B)	92015-1791	6
NUT,POP,6MM,L=16.5 (Ref # 92015C)	92015-1792	2
NUT,POP,8MM,L=16.5 (Ref # 92015D)	92015-1793	4
NUT,POP,8MM,L=18 (Ref # 92015E)	92015-1794	2
WASHER,CLAW,18.5X30X2.3 (Ref # 92022)	92022-1555	1
SEAL-OIL,XMHE36X52X4J (Ref # 92049)	92049-1162	1
SEAL-OIL,XXMH33 70 6.4J-A (Ref # 92049A)	92049-1313	1
RING-O,ID=24.5 (Ref # 92055)	92055-1459	1
BEARING-ROLLER,HR320/28XJ (Ref # 92116)	92116-1009	1
BEARING-ROLLER,HI-CAP32005JR-1 (Ref # 92116A)	92116-1056	1
BOLT,FLANGED,10X20 (Ref # 92150)	92150-1410	4
W-PLAIN-S (Ref # 410)	410F1800	1