

# 2025 MULE PRO-FXR 1000 PARTS DIAGRAM

Crankshaft

E1321

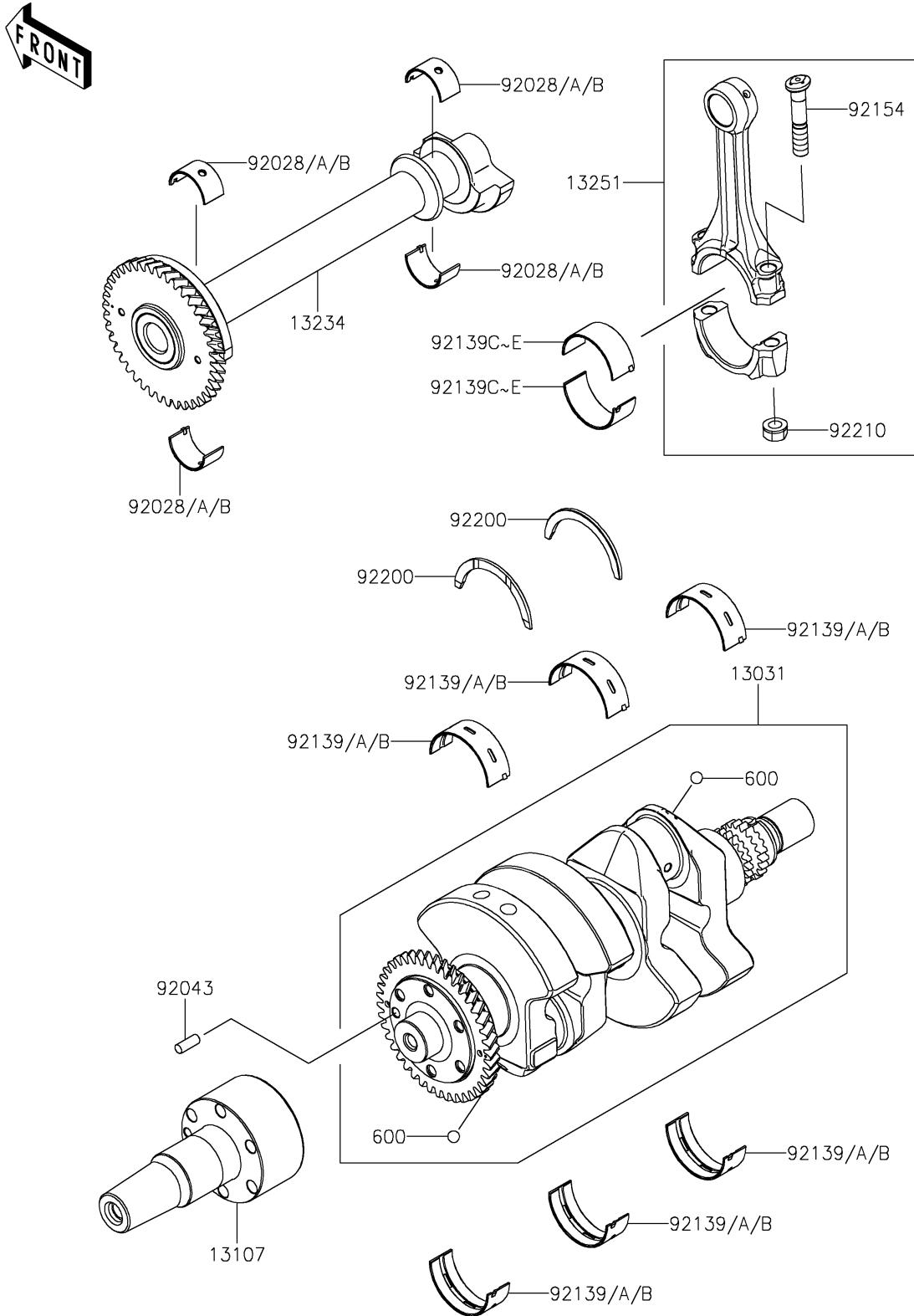

## 2025 MULE PRO-FXR 1000 PARTS LIST

### Crankshaft

ITEM NAME	PART NUMBER	QUANTITY
CRANKSHAFT-COMP (Ref # 13031)	13031-1531	1
SHAFT, CONVERTER-DRIVE (Ref # 13107)	13107-0982	1
SHAFT-COMP, BALANCER (Ref # 13234)	13234-0611	1
ROD-ASSY-CONNECTING, J (Ref # 13251)	13251-0749-JJ	2
BUSHING, BALANCER SHAFT, BLUE (Ref # 92028)	92028-1909	4
BUSHING, BALANCER SHAFT, BLACK (Ref # 92028A)	92028-1910	AR
BUSHING, BALANCER SHAFT, BROWN (Ref # 92028B)	92028-1911	AR
PIN, 6X16 (Ref # 92043)	92043-1690	1
BUSHING, CRANKSHAFT, BLUE (Ref # 92139)	92139-0925	6
BUSHING, CRANKSHAFT, BLACK (Ref # 92139A)	92139-0926	AR
BUSHING, CRANKSHAFT, BROWN (Ref # 92139B)	92139-0927	AR
BUSHING, CONNECTING ROD, BLUE (Ref # 92139C)	92139-1197	4
BUSHING, CONNECTING ROD, BLACK (Ref # 92139D)	92139-1198	AR
BUSHING, CONNECTING ROD, BROWN (Ref # 92139E)	92139-1199	AR
BOLT, CONNECTING ROD (Ref # 92154)	92154-3911	4
WASHER, THRUST, T=2.5 (Ref # 92200)	92200-2242	2
NUT, FLANGED, 9MM (Ref # 92210)	92210-1673	4
BALL-STEEL, 11/32 (Ref # 600)	600A1100	2