

2025 TERYX KRX® 1000 TRAIL EDITION PARTS DIAGRAM

Frame

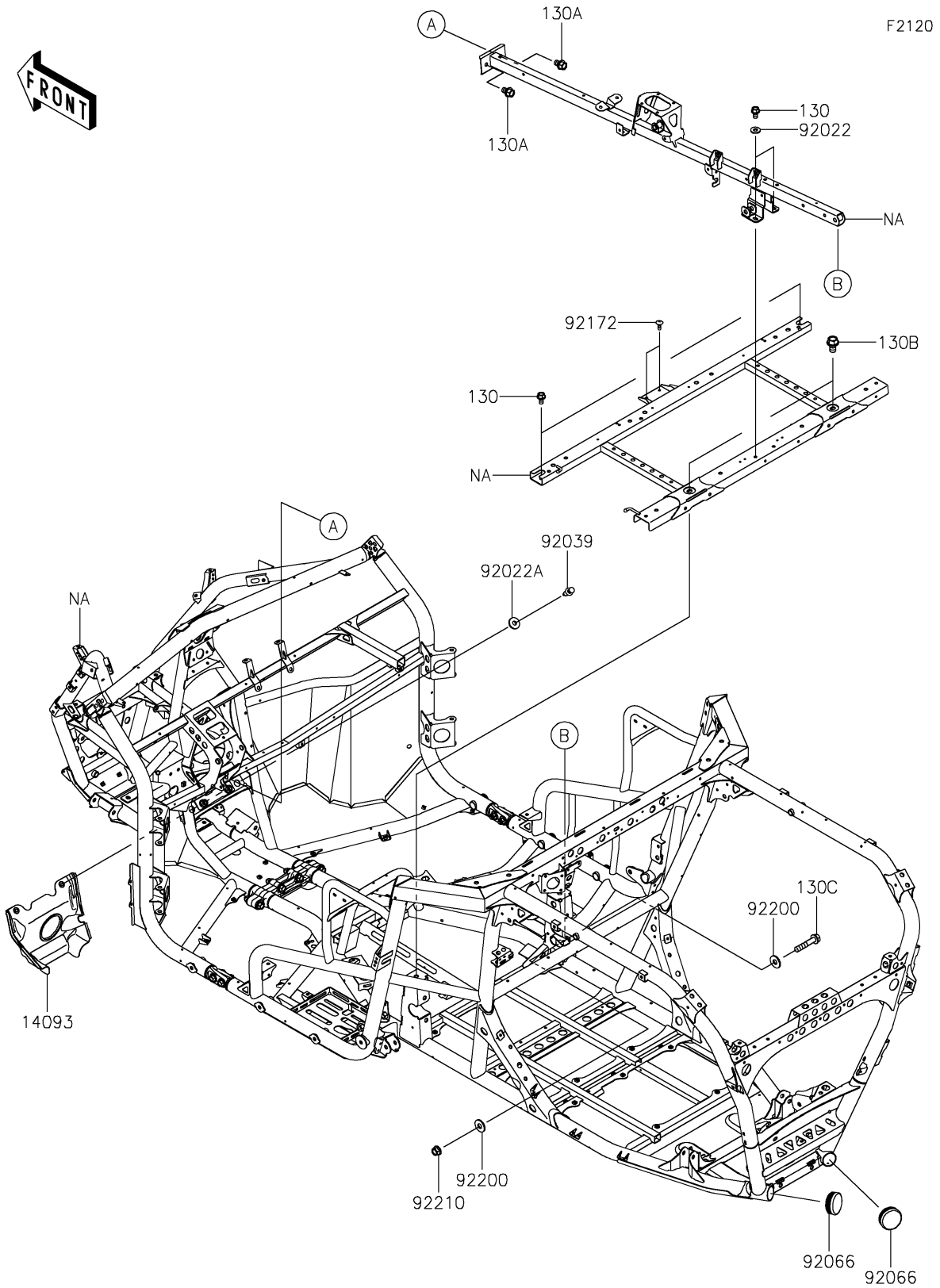

2025 TERYX KRX® 1000 TRAIL EDITION PARTS LIST

Frame

ITEM NAME	PART NUMBER	QUANTITY
COVER,PROPELLER SHAFT (Ref # 14093)	14093-1009	1
WASHER,8.2X19X2 (Ref # 92022)	92022-1533	2
WASHER,8.4X23X2.5 (Ref # 92022A)	92022-3744	2
RIVET (Ref # 92039)	92039-0776	2
PLUG,RR END (Ref # 92066)	92066-0926	2
SCREW,TAPPING,6X16 (Ref # 92172)	92172-0739	2
WASHER,11X26X2.6 (Ref # 92200)	92200-0352	2
NUT,LOCK,FLANGED,10MM (Ref # 92210)	92210-0276	1
BOLT-FLANGED,8X14 (Ref # 130)	130BA0814	4
BOLT-FLANGED,10X16 (Ref # 130A)	130BA1016	2
BOLT-FLANGED,12X20 (Ref # 130B)	130BA1220	2
BOLT-FLANGED,10X50 (Ref # 130C)	130CA1050	1