

# 1993 Ninja® ZX™ -6 PARTS DIAGRAM

Labels

F 2860

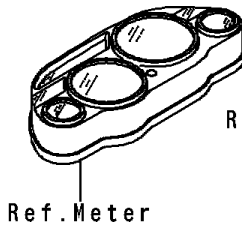
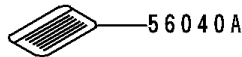
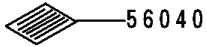
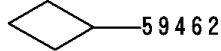
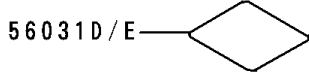
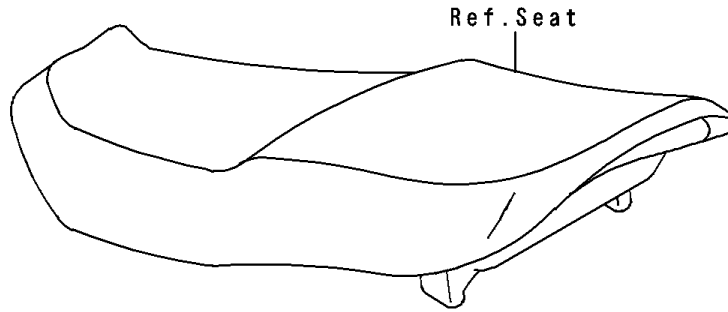

Ref. Fuel Tank

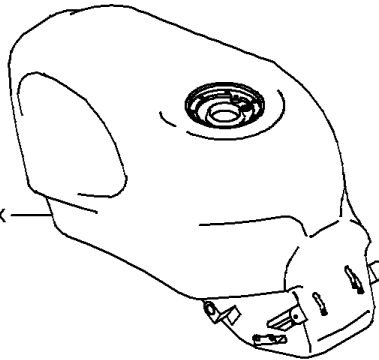

56031A/B

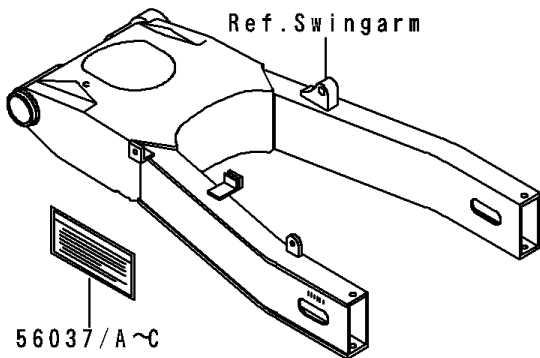

56037/A~C

Ref. Side Covers/Chain Cover

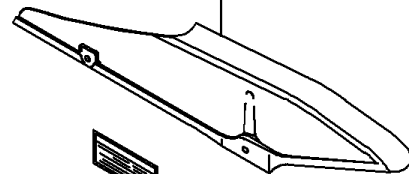

56031/C/F/G

# 1993 Ninja® ZX™ -6 PARTS LIST

## Labels

ITEM NAME	PART NUMBER	QUANTITY
LABEL-MANUAL,CHAIN (Ref # 56031)	56031-1512	1
LABEL-MANUAL,OIL&OIL FILTER (Ref # 56031A)	56031-1696	1
LABEL-MANUAL,OIL&OIL FILTER (Ref # 56031B)	56031-1697	1
LABEL-MANUAL,CHAIN (Ref # 56031C)	56031-1700	1
LABEL-MANUAL,DAILY SAFETY (Ref # 56031D)	56031-1841	1
LABEL-MANUAL,DAILY SAFETY (Ref # 56031E)	56031-1842	1
LABEL-SPECIFICATION,TIRE&LOAD (Ref # 56037)	56037-1604	1
LABEL-SPECIFICATION,TIRE&LOAD (Ref # 56037A)	56037-1606	1
LABEL-WARNING,BREAK IN CAUTION (Ref # 56040)	56040-1007	1
LABEL-WARNING,EVAPO (Ref # 56040A)	56040-1121	1
LABEL-CERTIFICATION,EVAPO ROUT (Ref # 59462)	59462-1520	1