

2023 KLR® 650 PARTS DIAGRAM

Muffler(s)

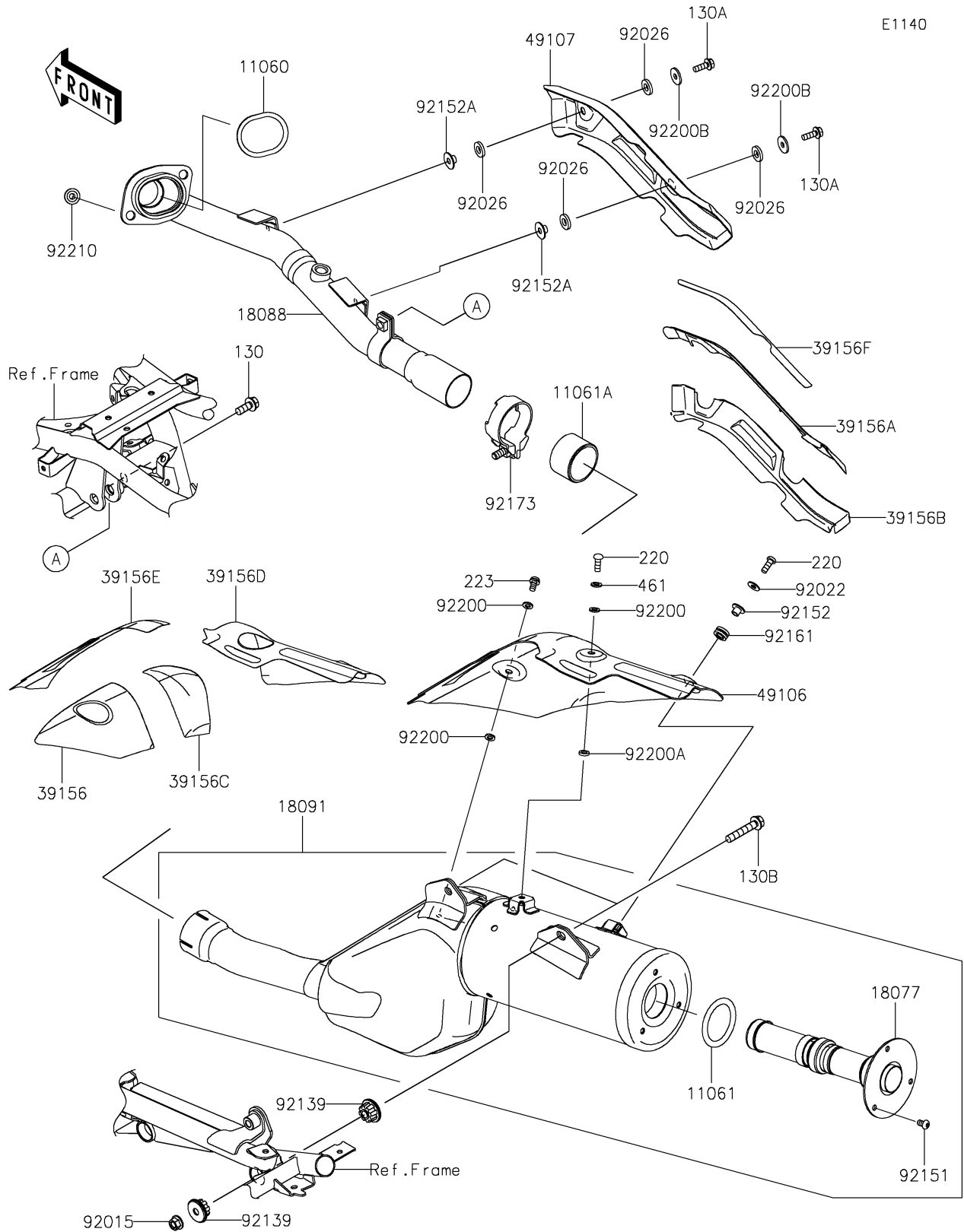

E1140

2023 KLR® 650 PARTS LIST

Muffler(s)

| ITEM NAME | PART NUMBER | QUANTITY |
|---|-------------|----------|
| GASKET,EXHAUST PIPE HOLDER (Ref # 11060) | 11060-1108 | 1 |
| GASKET (Ref # 11061) | 11061-1345 | 1 |
| GASKET,EXHAUST PIPE CONNECTING (Ref # 11061A) | 11061-1411 | 1 |
| ARRESTER-SPARK (Ref # 18077) | 18077-0050 | 1 |
| PIPE-EXHAUST (Ref # 18088) | 18088-1665 | 1 |
| BODY-COMP-MUFFLER (Ref # 18091) | 18091-1268 | 1 |
| PAD,MUFFLER COVER,FR (Ref # 39156) | 39156-2693 | 1 |
| PAD,EXHAUST PIPE COVER,CNT (Ref # 39156A) | 39156-2698 | 1 |
| PAD,EXHAUST PIPE COVER,LWR (Ref # 39156B) | 39156-2699 | 1 |
| PAD,MUFFLER COVER,CNT (Ref # 39156C) | 39156-2738 | 1 |
| PAD,MUFFLER COVER,RR (Ref # 39156D) | 39156-2773 | 1 |
| PAD,MUFFLER COVER,UPP (Ref # 39156E) | 39156-2774 | 1 |
| PAD,EXHAUST PIPE COVER,UPP (Ref # 39156F) | 39156-2798 | 1 |
| COVER-MUFFLER (Ref # 49106) | 49106-0857 | 1 |
| COVER-EXHAUST PIPE (Ref # 49107) | 49107-0849 | 1 |
| NUT,8MM (Ref # 92015) | 92015-1402 | 2 |
| WASHER,6.2X15X1.2 (Ref # 92022) | 92022-2373 | 1 |
| SPACER,8.7X18X3 (Ref # 92026) | 92026-0919 | 4 |
| BUSHING (Ref # 92139) | 92139-1116 | 4 |
| BOLT,SOCKET,6X10 (Ref # 92151) | 92151-1449 | 3 |
| COLLAR (Ref # 92152) | 92152-2837 | 1 |
| COLLAR (Ref # 92152A) | 92152-2862 | 2 |
| DAMPER (Ref # 92161) | 92161-2434 | 1 |
| CLAMP (Ref # 92173) | 92173-2463 | 1 |
| WASHER,6.2X11.5X1.5 (Ref # 92200) | 92200-2496 | 3 |
| WASHER,6.2X11.5X2.5 (Ref # 92200A) | 92200-2511 | 1 |
| WASHER,6.5X20X2 (Ref # 92200B) | 92200-2529 | 2 |
| NUT,8MM (Ref # 92210) | 92210-1114 | 2 |
| BOLT-FLANGED,8X20 (Ref # 130) | 130BD0820 | 1 |

2023 KLR® 650 PARTS LIST

Muffler(s)

| ITEM NAME | PART NUMBER | QUANTITY |
|------------------------------------|-------------|----------|
| BOLT-FLANGED,6X18 (Ref # 130A) | 130CB0618 | 2 |
| BOLT-FLANGED (Ref # 130B) | 130CC0845 | 2 |
| SCREW-PAN-CROS,6X16 (Ref # 220) | 220AB0616 | 2 |
| SCREW-PAN-WS-CROS,6X12 (Ref # 223) | 223AB0612 | 1 |
| WASHER-SPRING,6MM (Ref # 461) | 461DB0600 | 1 |