

# 2024 KLR® 650 PARTS DIAGRAM

Gear Change Mechanism

E1370

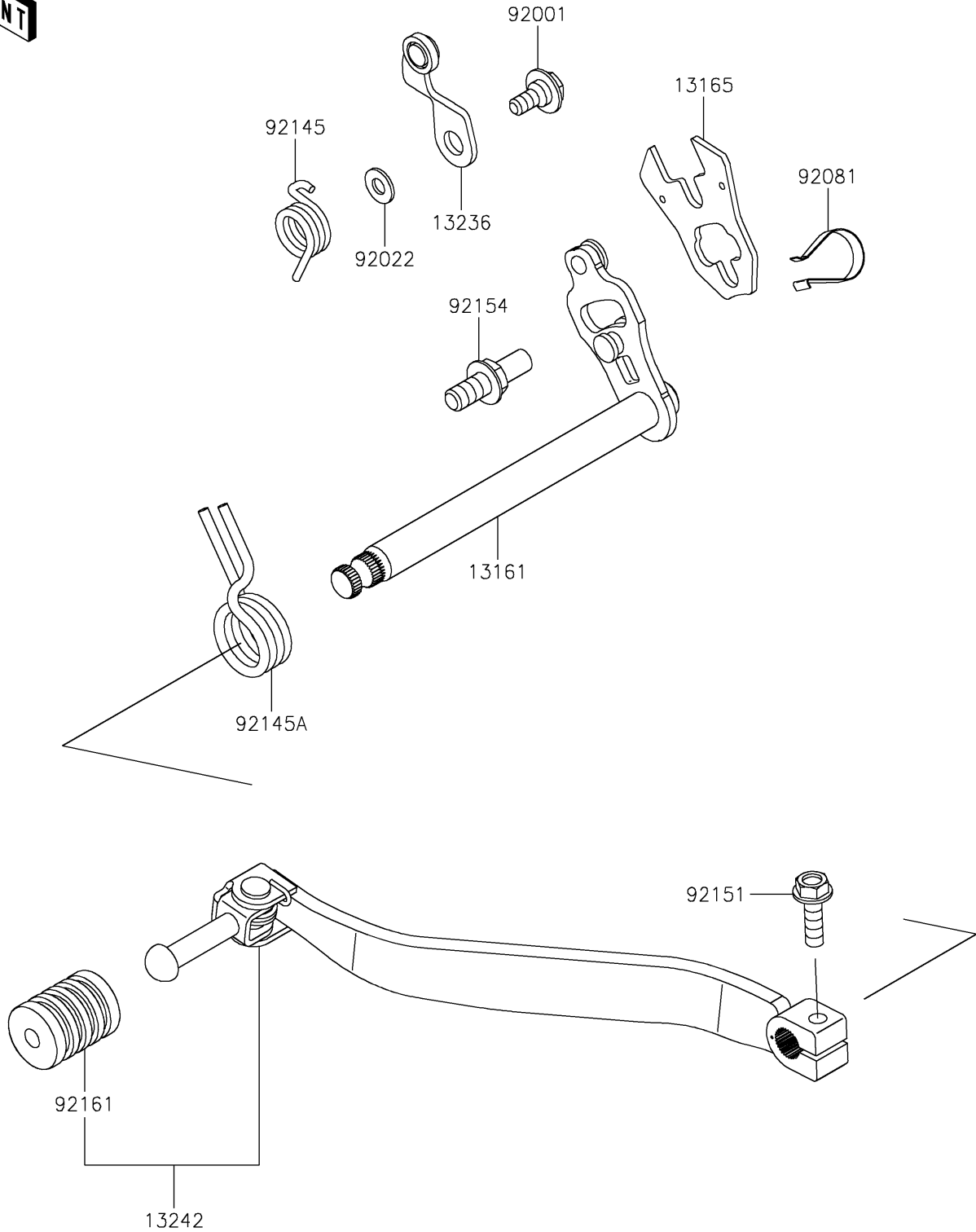

## 2024 KLR® 650 PARTS LIST

### Gear Change Mechanism

ITEM NAME	PART NUMBER	QUANTITY
LEVER-COMP-CHANGE SHAFT (Ref # 13161)	13161-0065	1
PAWL (Ref # 13165)	13165-1120	1
LEVER-COMP (Ref # 13236)	13236-0200	1
LEVER-ASSY-CHANGE (Ref # 13242)	13242-0252	1
BOLT,FLANGED,6X14 (Ref # 92001)	92001-1715	1
WASHER,6X12.8X1.2 (Ref # 92022)	92022-1827	1
SPRING,CHANGE LEVER (Ref # 92081)	92081-1493	1
SPRING (Ref # 92145)	92145-0773	1
SPRING,CHANGE PEDAL RETURN (Ref # 92145A)	92145-0774	1
BOLT,6X20 (Ref # 92151)	92151-1450	1
BOLT,RETURN SPRING (Ref # 92154)	92154-1838	1
DAMPER,CHANGE PEDAL (Ref # 92161)	92161-1652	1