

# 2023 KLR® 650 PARTS DIAGRAM

## Front Fork

F2340

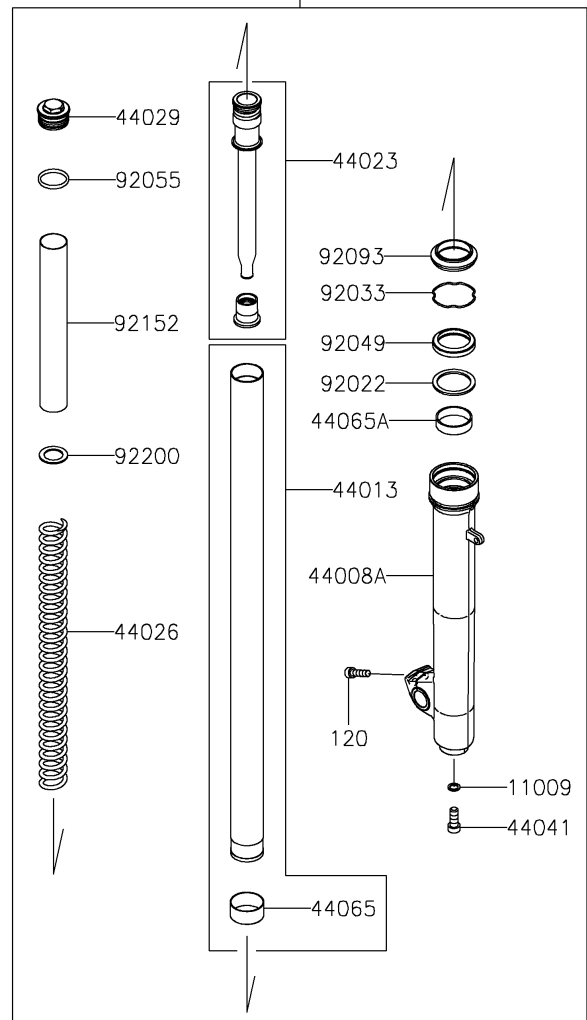
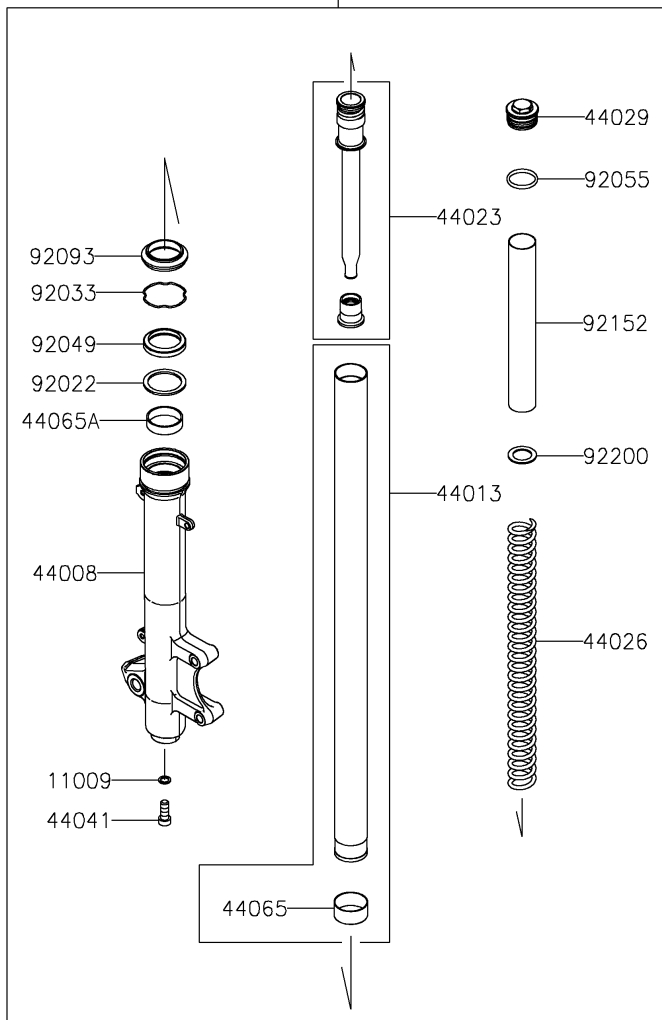
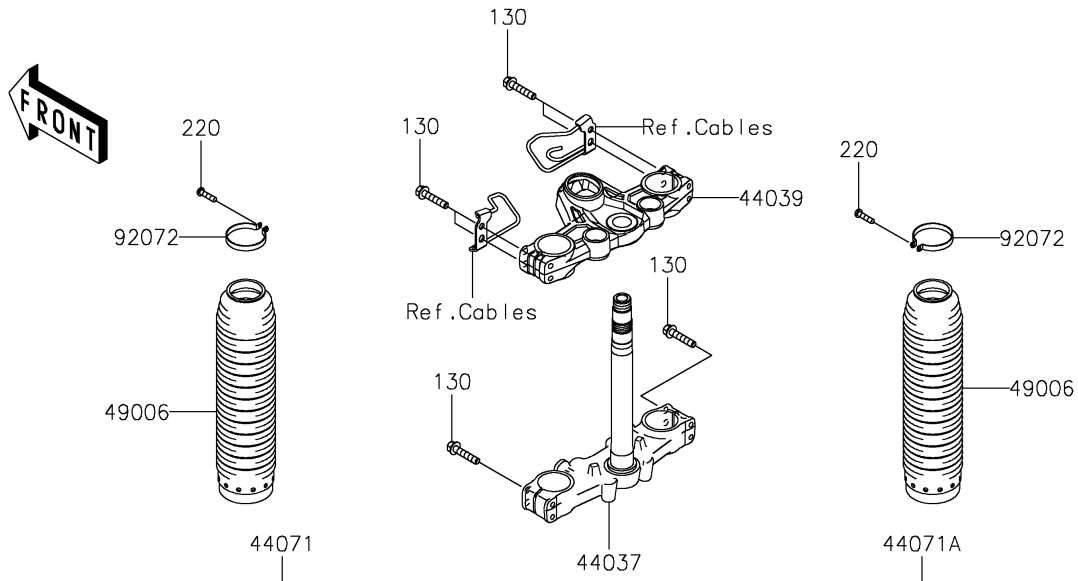

## 2023 KLR® 650 PARTS LIST

### Front Fork

ITEM NAME	PART NUMBER	QUANTITY
GASKET,10.5X15X1.5 (Ref # 11009)	11009-1325	2
PIPE-FORK OUTER (Ref # 44008)	44008-0097	1
PIPE-FORK OUTER (Ref # 44008A)	44008-0098	1
PIPE-FORK INNER (Ref # 44013)	44013-0107	2
CYLINDER-SET-FORK (Ref # 44023)	44023-0177	2
SPRING-FRONT FORK (Ref # 44026)	44026-0268	2
SEAT-FORK SPRING (Ref # 44029)	44029-0005	2
HOLDER-FORK UNDER (Ref # 44037)	44037-0206	1
HOLDER-FORK UPPER (Ref # 44039)	44039-0202	1
BOLT,SOCKET,FORK CYLINDER (Ref # 44041)	44041-040	2
BUSHING-FRONT FORK,INNER TUBE (Ref # 44065)	44065-0014	2
BUSHING-FRONT FORK,OUTER TUBE (Ref # 44065A)	44065-1115	2
DAMPER-ASSY,FORK,LH (Ref # 44071)	44071-1487	1
DAMPER-ASSY,FORK,RH (Ref # 44071A)	44071-1488	1
BOOT (Ref # 49006)	49006-0645	2
WASHER,FORK OUTER TUBE (Ref # 92022)	92022-1298	2
RING-SNAP (Ref # 92033)	92033-1036	2
SEAL-OIL,FORK OUTER TUBE (Ref # 92049)	92049-1356	2
RING-O (Ref # 92055)	92055-1321	2
BAND,BOOT (Ref # 92072)	92072-1077	2
SEAL,DUST (Ref # 92093)	92093-0036	2
COLLAR,FORK (Ref # 92152)	92152-0410	2
WASHER (Ref # 92200)	92200-1467	2
BOLT-SOCKET,8X30 (Ref # 120)	120CA0830	2
BOLT-FLANGED,8X40 (Ref # 130)	130BA0840	8
SCREW-PAN-CROS,4X16 (Ref # 220)	220AB0416	2