

# 1996 Ninja® ZX™-6R PARTS DIAGRAM

Rear Wheel/Chain

F2240

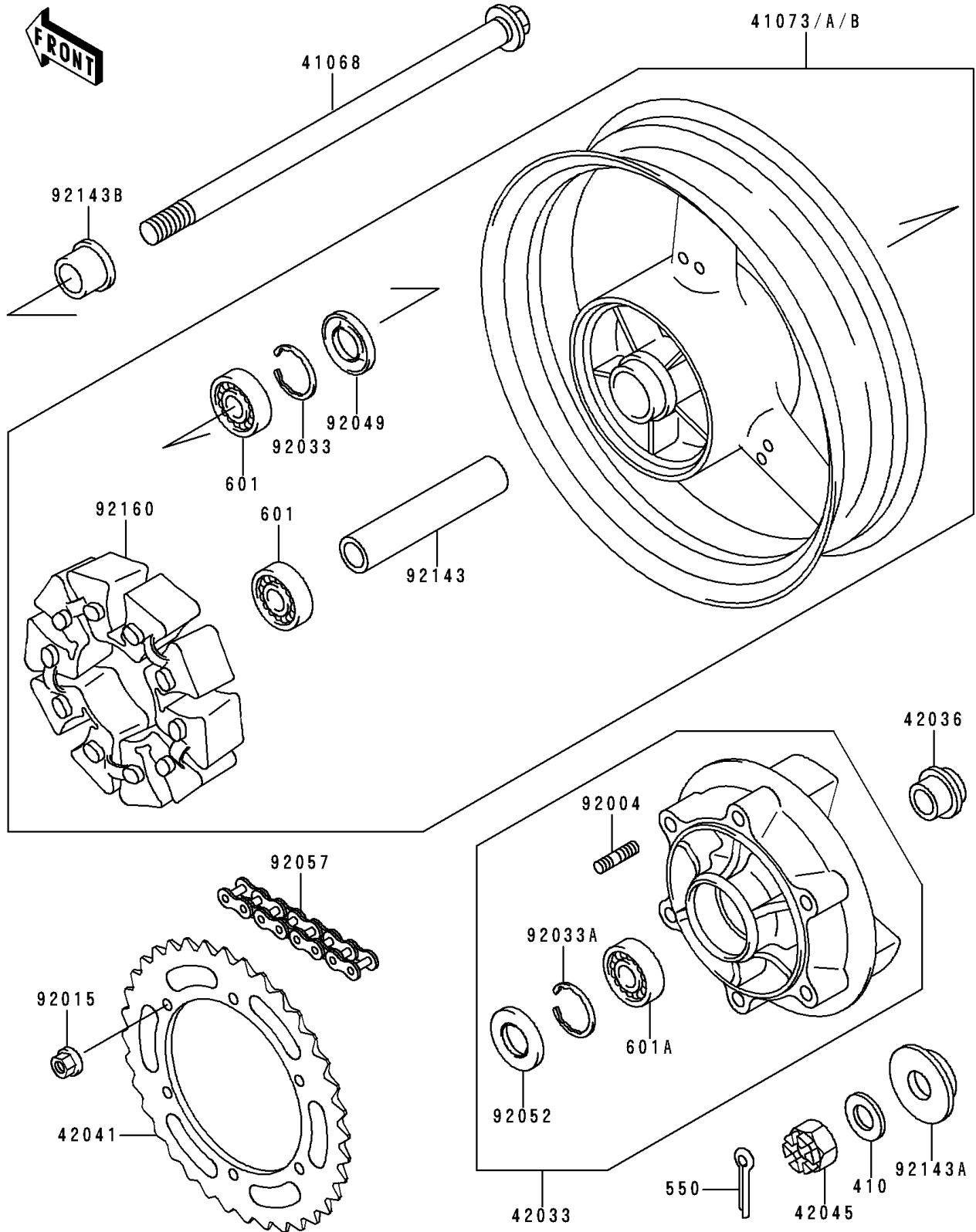

# 1996 Ninja® ZX™-6R PARTS LIST

## Rear Wheel/Chain

ITEM NAME	PART NUMBER	QUANTITY
W-PLAIN-S,18MM (Ref # 410)	410D1800	1
PIN-COTTER,4.0X35 (Ref # 550)	550D4035	1
BEARING-BALL,6204UUC3 (Ref # 601)	601B6204UU	2
BEARING-BALL,#6205G (Ref # 601A)	601B6205G	1
AXLE,RR (Ref # 41068)	41068-1350	1
WHEEL-ASSY,RR,L.GREEN (Ref # 41073)	41073-1589-CJ	1
WHEEL-ASSY,RR,C.GRAY (Ref # 41073A)	41073-1589-DH	1
COUPLING-ASSY,RR HUB (Ref # 42033)	42033-1171	1
SLEEVE,RR HUB,L=23 (Ref # 42036)	42036-1251	1
SPROCKET-HUB,40T (Ref # 42041)	42041-1435	1
NUT,CASTLE,18MM (Ref # 42045)	42045-018	1
STUD,10X19.5 (Ref # 92004)	92004-1151	6
NUT,10MM (Ref # 92015)	92015-1720	6
RING-SNAP,47MM (Ref # 92033)	92033-1042	1
RING-SNAP,52MM (Ref # 92033A)	92033-1043	1
SEAL-OIL,BJN28475 (Ref # 92049)	92049-1056	1
SEAL-OIL,TWC35527 (Ref # 92052)	92052-006	1
CHAIN,DRIVE,EK525MV-XX108L (Ref # 92057)	92057-1398	1
COLLAR,RR HUB,L=133 (Ref # 92143)	92143-1303	1
COLLAR,RR AXLE,LH,L=15.5 (Ref # 92143A)	92143-1808	1
COLLAR,RR AXLE,RH,L=22.5 (Ref # 92143B)	92143-1809	1
DAMPER,SHOCK,RR HUB (Ref # 92160)	92160-1524	1