

1999 Ninja® ZX™-6R PARTS DIAGRAM

Gasket Kit

F2885

99996

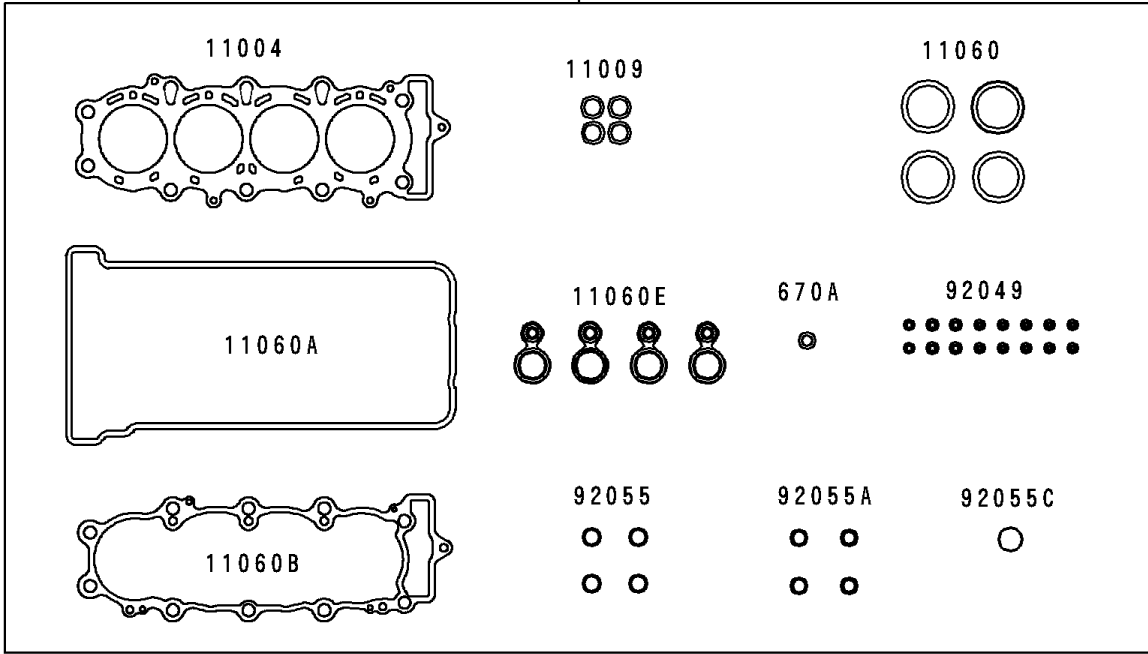

99996A

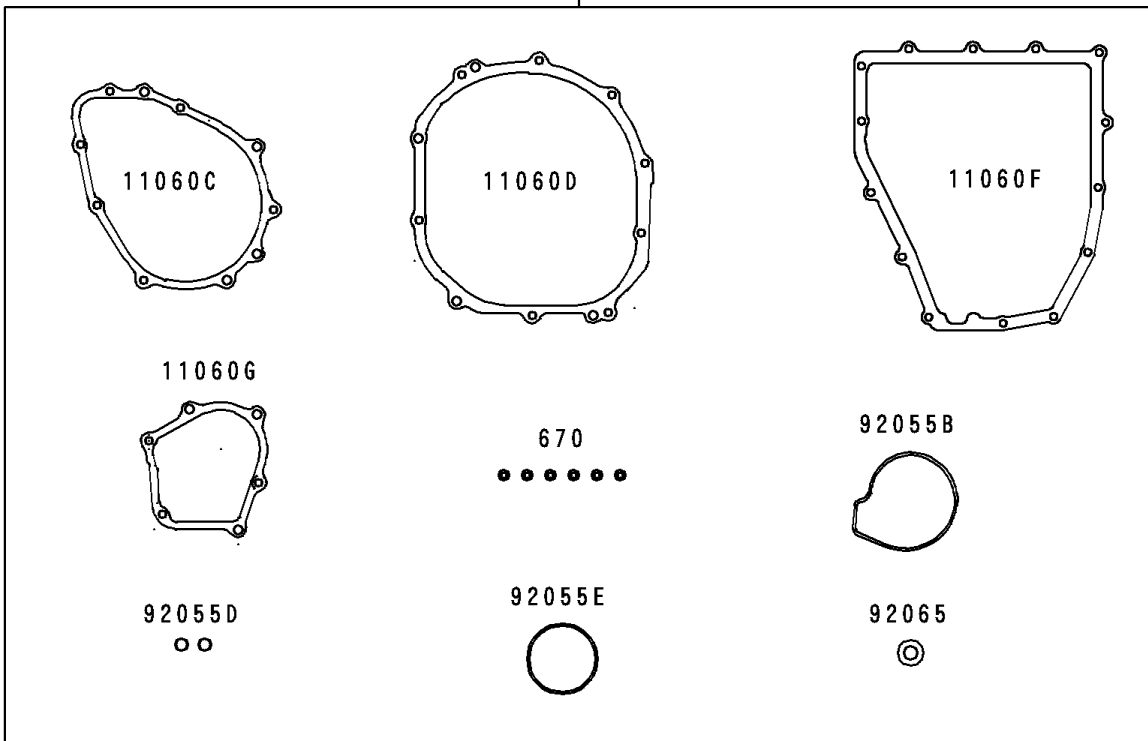

1999 Ninja® ZX™-6R PARTS LIST

Gasket Kit

ITEM NAME	PART NUMBER	QUANTITY
O RING (Ref # 670)	670D1505	AR
O RING (Ref # 670A)	670D2010	AR
GASKET-HEAD (Ref # 11004)	11004-1303	AR
GASKET,14X19.5X1.4 (Ref # 11009)	11009-1461	AR
GASKET,EXHAUST PIPE (Ref # 11060)	11060-1203	AR
GASKET,HEAD COVER (Ref # 11060A)	11060-1667	AR
GASKET,CYLINDER BASE (Ref # 11060B)	11060-1844	AR
GASKET,GENERATOR COVER (Ref # 11060C)	11060-1851	AR
GASKET,CLUTCH COVER (Ref # 11060D)	11060-1853	AR
GASKET,BEARING CAP (Ref # 11060E)	11060-1861	AR
GASKET,OIL PAN (Ref # 11060F)	11060-1866	AR
GASKET,PULSING COVER (Ref # 11060G)	11060-1867	AR
SEAL-OIL,VALVE GUIDE (Ref # 92049)	92049-1308	AR
RING-O,25.5X2 (Ref # 92055)	92055-1403	AR
RING-O,11.5X1.5 (Ref # 92055A)	92055-1469	AR
RING-O,WATER PUMP COVER (Ref # 92055B)	92055-1532	AR
RING-O,TENSIONER (Ref # 92055C)	92055-1583	AR
RING-O,9.5X1.9 (Ref # 92055D)	92055-1591	AR
RING-O (Ref # 92055E)	92055-3018	AR
GASKET,12X22X2,DRAIN PLUG (Ref # 92065)	92065-097	AR
KIT,GASKET TOP END,ZX600G (Ref # 99996)	99996-1274	AR
KIT,GASKET BOTTOM END,ZX600G (Ref # 99996A)	99996-1275	AR