

2025 TERYX4™ PARTS DIAGRAM

Front Bevel Gear

E3131

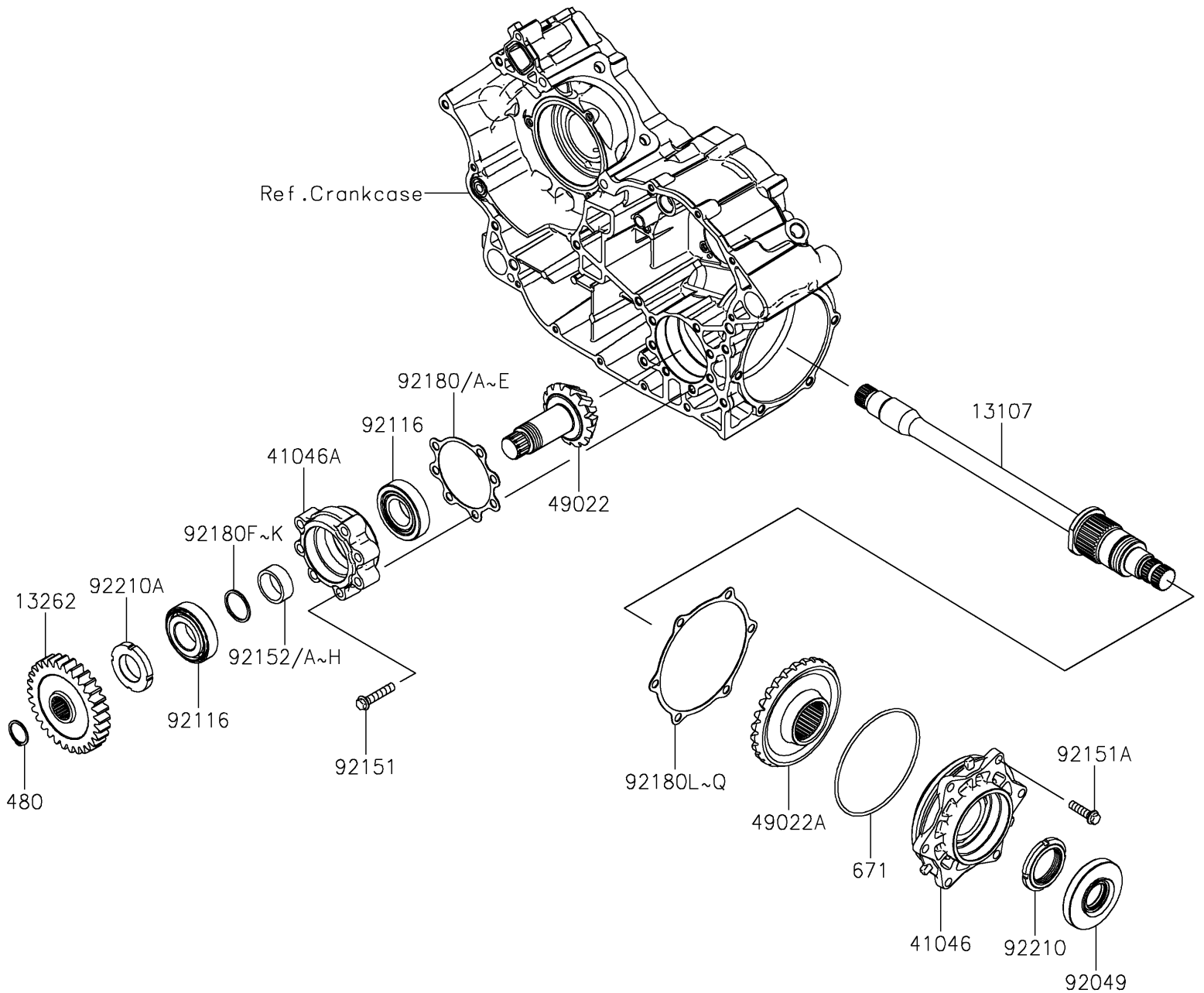

2025 TERYX4™ PARTS LIST

Front Bevel Gear

ITEM NAME	PART NUMBER	QUANTITY
SHAFT,OUTPUT (Ref # 13107)	13107-0766	1
GEAR,OUTPUT,30T (Ref # 13262)	13262-1142	1
HOUSING-BEARING,DRIVEN (Ref # 41046)	41046-0026	1
HOUSING-BEARING,DRIVE (Ref # 41046A)	41046-0040	1
GEAR-BEVEL,PINION,14T (Ref # 49022)	49022-0602	1
GEAR-BEVEL,DRIVEN,27T (Ref # 49022A)	49022-0603	1
SEAL-OIL (Ref # 92049)	92049-0712	1
BEARING-ROLLER,HR30206JUQU42 (Ref # 92116)	92116-0568	2
BOLT,8X40 (Ref # 92151)	92151-1621	7
BOLT-FLANGED-SMALL,8X30 (Ref # 92151A)	92151-1688	6
COLLAR,30.2X37X13.1 (Ref # 92152)	92152-0947	AR
COLLAR,30.2X37X13.2 (Ref # 92152A)	92152-0948	AR
COLLAR,30.2X37X13.3 (Ref # 92152B)	92152-0949	AR
COLLAR,30.2X37X13.4 (Ref # 92152C)	92152-0950	AR
COLLAR,30.2X37X13.5 (Ref # 92152D)	92152-0951	AR
COLLAR,30.2X37X13.6 (Ref # 92152E)	92152-0952	AR
COLLAR,30.2X37X13.7 (Ref # 92152F)	92152-0953	1
COLLAR,30.2X37X13.8 (Ref # 92152G)	92152-0954	AR
COLLAR,30.2X37X13.9 (Ref # 92152H)	92152-0955	AR
SHIM,DRIVE,T=0.15 (Ref # 92180)	92180-0702	AR
SHIM,DRIVE,T=0.20 (Ref # 92180A)	92180-0703	AR
SHIM,DRIVE,T=0.50 (Ref # 92180B)	92180-0704	AR
SHIM,DRIVE,T=0.80 (Ref # 92180C)	92180-0705	AR
SHIM,DRIVE,T=1.0 (Ref # 92180D)	92180-0706	1
SHIM,DRIVE,T=1.2 (Ref # 92180E)	92180-0707	AR
SHIM,DRIVE,T=1.70 (Ref # 92180F)	92180-0708	AR
SHIM,DRIVE,T=1.72 (Ref # 92180G)	92180-0709	AR
SHIM,DRIVE,T=1.74 (Ref # 92180H)	92180-0710	AR
SHIM,DRIVE,T=1.76 (Ref # 92180I)	92180-0711	AR

2025 TERYX4™ PARTS LIST

Front Bevel Gear

ITEM NAME	PART NUMBER	QUANTITY
SHIM,DRIVE,T=1.78 (Ref # 92180J)	92180-0712	1
SHIM,DRIVE,T=1.80 (Ref # 92180K)	92180-0713	AR
SHIM,DRIVEN,T=0.15 (Ref # 92180L)	92180-0714	AR
SHIM,DRIVEN,T=0.20 (Ref # 92180M)	92180-0715	AR
SHIM,DRIVEN,T=0.50 (Ref # 92180N)	92180-0716	AR
SHIM,DRIVEN,T=0.80 (Ref # 92180O)	92180-0717	AR
SHIM,DRIVEN,T=1.0 (Ref # 92180P)	92180-0718	1
SHIM,DRIVEN,T=1.2 (Ref # 92180Q)	92180-0719	AR
NUT,40MM (Ref # 92210)	92210-1893	1
NUT (Ref # 92210A)	92210-1915	1
CIRCLIP-TYPE-C,24MM (Ref # 480)	480J2400	1
O RING,115MM (Ref # 671)	671D25115	1