

2000 Ninja® ZX™-6R PARTS DIAGRAM

Meter(s)

F2530

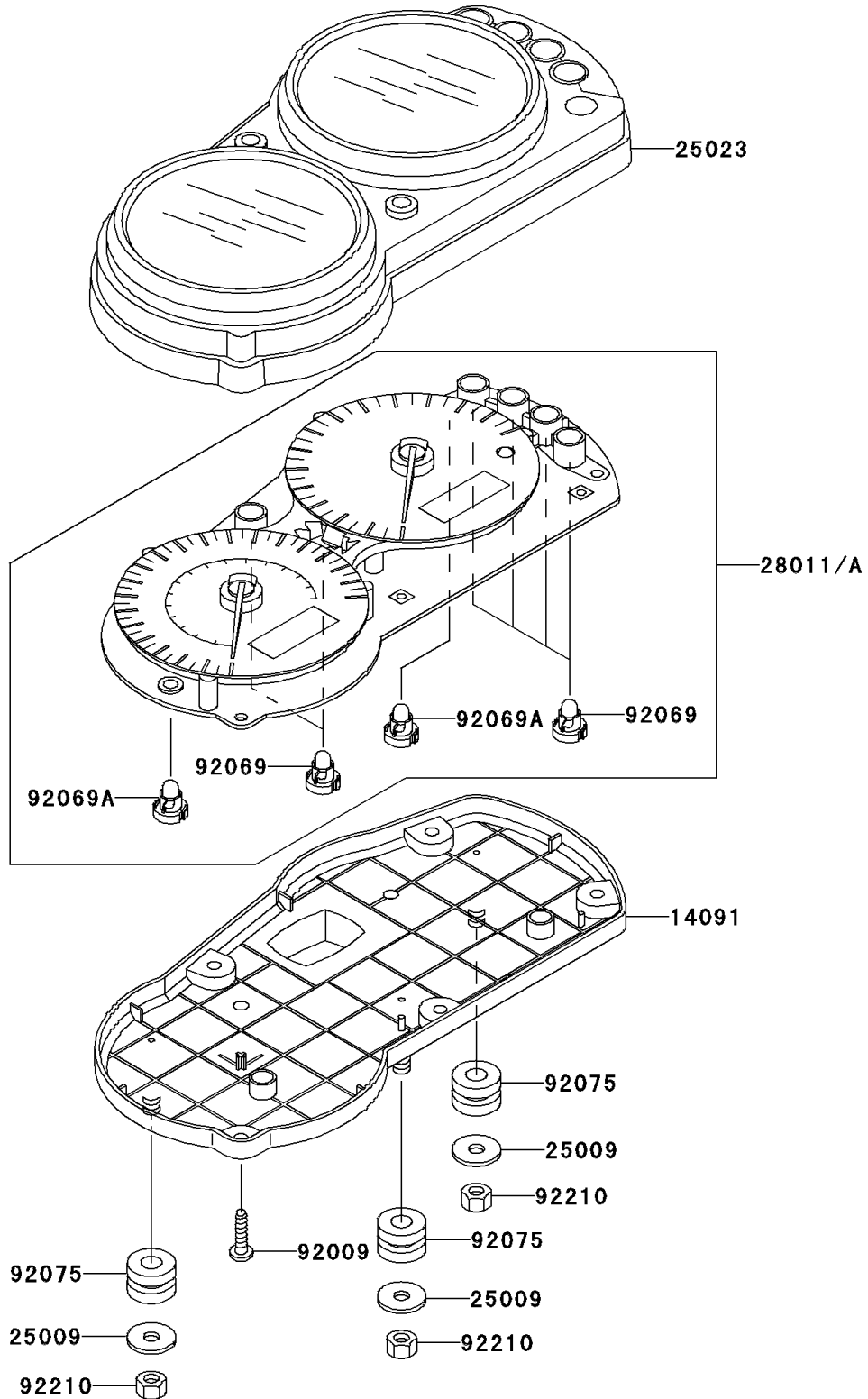

2000 Ninja® ZX™-6R PARTS LIST

Meter(s)

ITEM NAME	PART NUMBER	QUANTITY
COVER,METER HOUSING (Ref # 14091)	14091-1160	1
WASHER,5.2X16X1.2 (Ref # 25009)	25009-004	3
COVER-METER CASE,UPP (Ref # 25023)	25023-1253	1
SCREW,4X16,BLACK (Ref # 92009)	92009-1158	5
BULB,T3.4,12V1.1W (Ref # 92069)	92069-1110	6
BULB,T3,12V0.7W (Ref # 92069A)	92069-1113	2
DAMPER,METER BRACKET (Ref # 92075)	92075-1435	3
NUT,5MM (Ref # 92210)	92210-1124	3
METER,SPEED&TACHO,KPH (Ref # 28011)	28011-1201	1
METER,SPEED&TACHO,MPH (Ref # 28011A)	28011-1203	1