

2025 RIDGE® HVAC CAMO PARTS DIAGRAM

Starter Motor

E1840

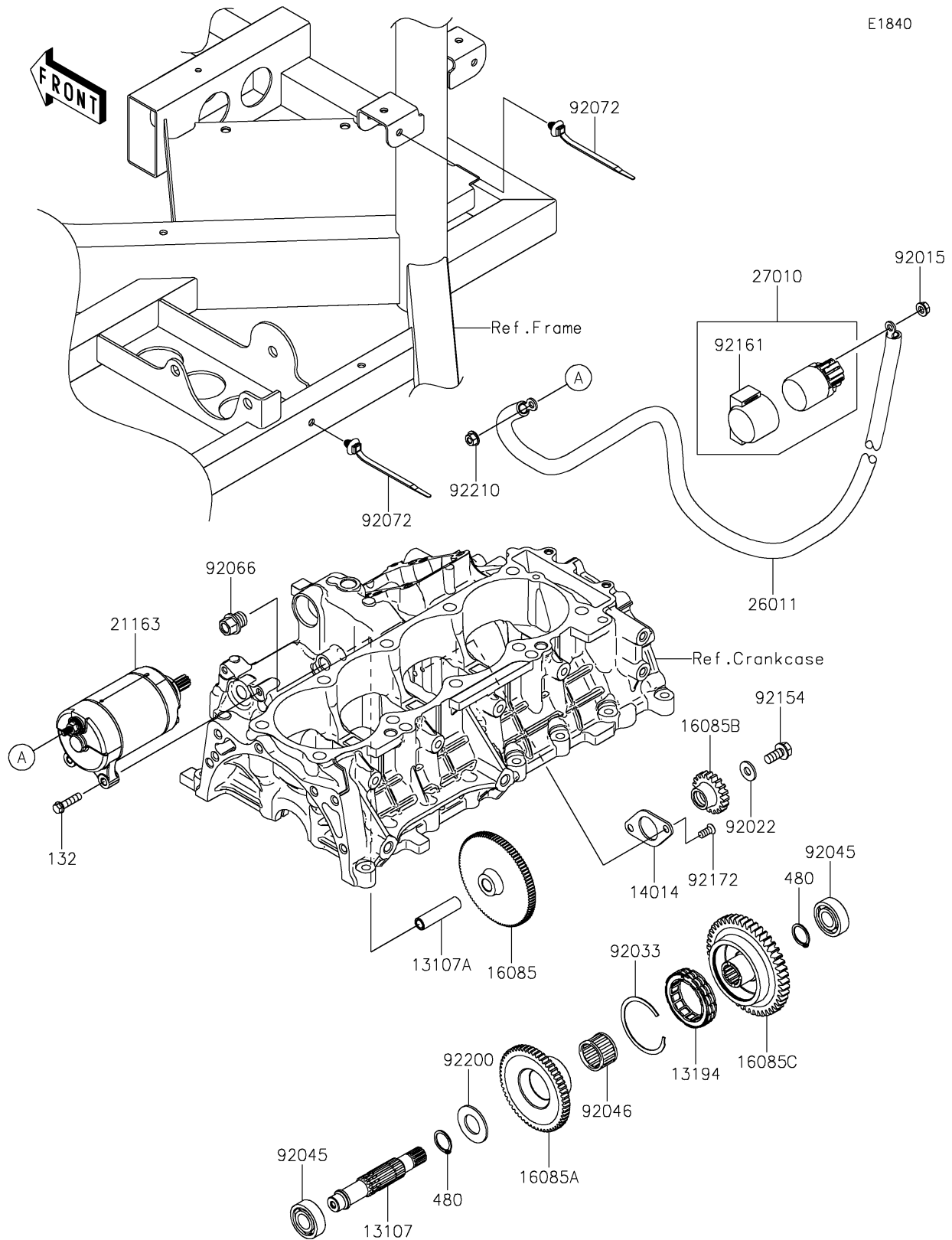

2025 RIDGE® HVAC CAMO PARTS LIST

Starter Motor

ITEM NAME	PART NUMBER	QUANTITY
SHAFT (Ref # 13107)	13107-0972	1
SHAFT,LIMITER GEAR (Ref # 13107A)	13107-0973	1
CLUTCH-ONEWAY (Ref # 13194)	13194-0027	1
PLATE-POSITION,COUNTER SHAFT (Ref # 14014)	14014-0572	1
GEAR,LIMITER (Ref # 16085)	16085-0731	1
GEAR,LIMITER (Ref # 16085A)	16085-0733	1
GEAR,PUMP-OIL (Ref # 16085B)	16085-0734	1
GEAR,CRANKSHAFT (Ref # 16085C)	16085-0752	1
STARTER-ELECTRIC (Ref # 21163)	21163-0806	1
WIRE-LEAD,STARTER-ELECTRIC (Ref # 26011)	26011-2418	1
SWITCH,MAGNETIC (Ref # 27010)	27010-0766	1
NUT,FLANGED,6MM (Ref # 92015)	92015-1367	1
WASHER,8.2X19X2 (Ref # 92022)	92022-1533	1
RING-SNAP (Ref # 92033)	92033-3731	1
BEARING-BALL,6202ZC3 (Ref # 92045)	92045-0785	2
BEARING-NEEDLE,RS263020 (Ref # 92046)	92046-0004	1
PLUG (Ref # 92066)	92066-0998	1
BAND,OS170-FT7(BLACK) (Ref # 92072)	92072-1414	2
BOLT-FLANGED,8X16 (Ref # 92154)	92154-2670	1
DAMPER,MAGNETIC SWITCH (Ref # 92161)	92161-1722	1
SCREW,TORX,6X14 (Ref # 92172)	92172-0961	2
WASHER,19.6X37.0X2.0 (Ref # 92200)	92200-2556	1
NUT,6MM (Ref # 92210)	92210-0188	1
BOLT-FLANGED-SMALL,6X25 (Ref # 132)	132BA0625	2
CIRCLIP-TYPE-C,19MM (Ref # 480)	480J1900	2