

2024 Ninja 500 PARTS DIAGRAM

Water Pipe

E3037

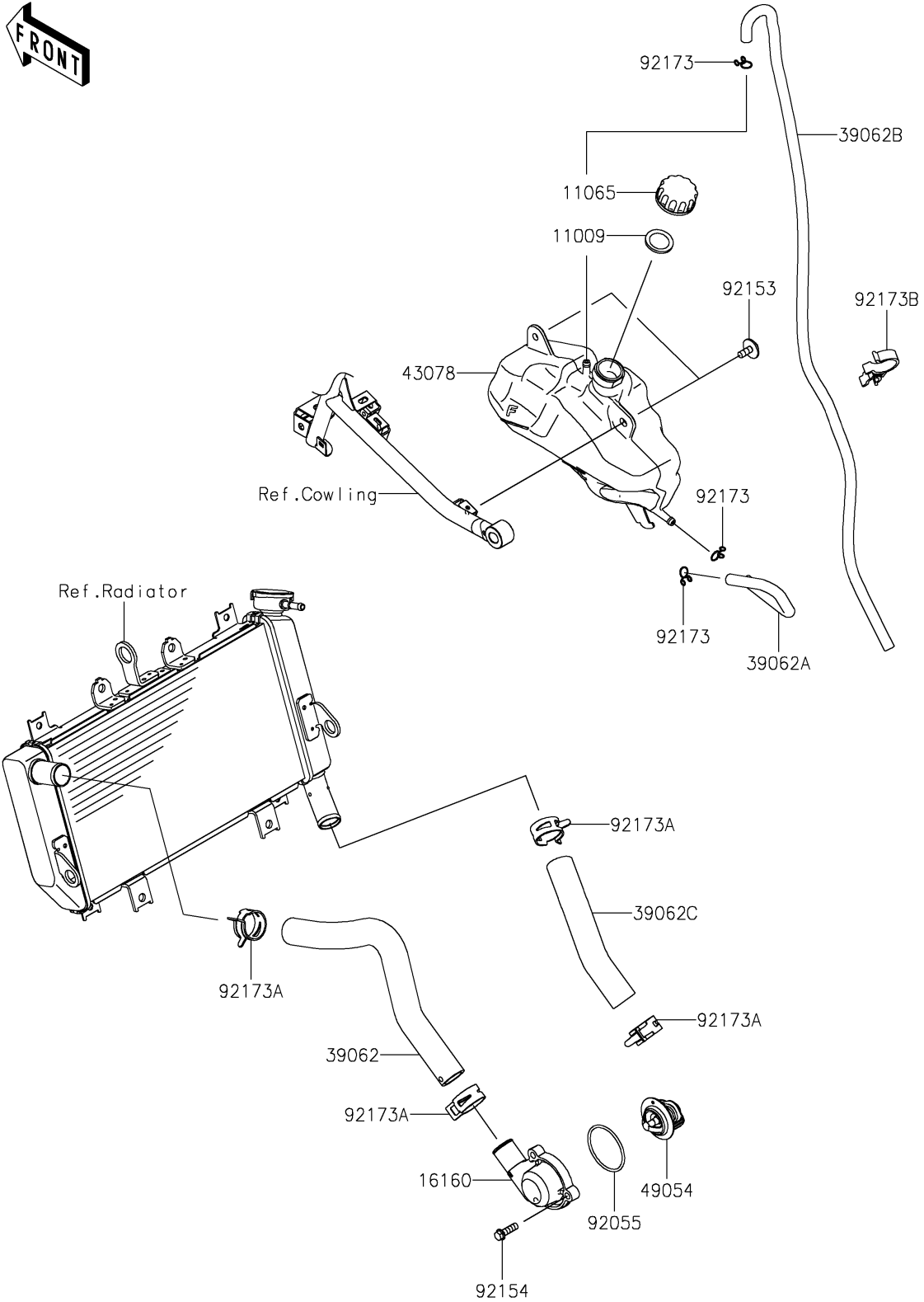

2024 Ninja 500 PARTS LIST

Water Pipe

| ITEM NAME | PART NUMBER | QUANTITY |
|---|-------------|----------|
| GASKET,RESERVOIR TANK CAP (Ref # 11009) | 11009-1145 | 1 |
| CAP (Ref # 11065) | 11065-0969 | 1 |
| BODY,THERMOSTAT (Ref # 16160) | 16160-0830 | 1 |
| HOSE-COOLING,THERMO.-RADIATOR (Ref # 39062) | 39062-0781 | 1 |
| HOSE-COOLING,RAD.-RESERVOIR (Ref # 39062A) | 39062-0784 | 1 |
| HOSE-COOLING,OVER FLOW (Ref # 39062B) | 39062-0823 | 1 |
| HOSE-COOLING,RADIATOR-W/PUMP (Ref # 39062C) | 39062-0861 | 1 |
| RESERVOIR (Ref # 43078) | 43078-0600 | 1 |
| THERMOSTAT (Ref # 49054) | 49054-0001 | 1 |
| RING-O,46.7X2.4 (Ref # 92055) | 92055-0992 | 1 |
| BOLT,FLANGED-SMALL,6X16 (Ref # 92153) | 92153-1798 | 2 |
| BOLT,FLANGED,6X20 (Ref # 92154) | 92154-1778 | 3 |
| CLAMP (Ref # 92173) | 92173-0050 | 3 |
| CLAMP (Ref # 92173A) | 92173-1688 | 4 |
| CLAMP (Ref # 92173B) | 92173-1691 | 1 |