

2024 Ninja 500 PARTS DIAGRAM

Meter(s)

F2530

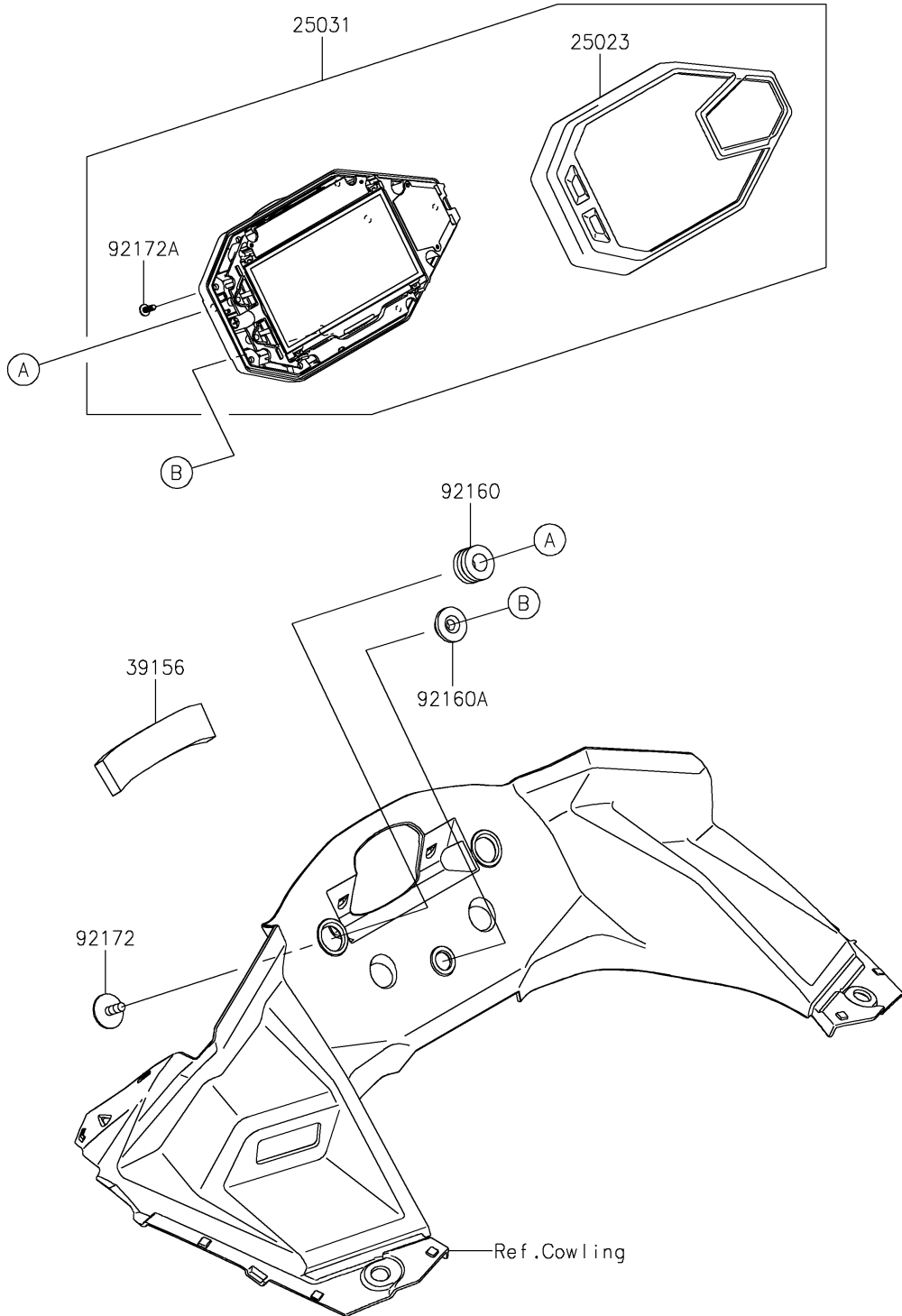

2024 Ninja 500 PARTS LIST

Meter(s)

ITEM NAME	PART NUMBER	QUANTITY
COVER-METER CASE,UPP (Ref # 25023)	25023-0156	1
METER-ASSY,COMBINATION (Ref # 25031)	25031-1367	1
PAD,80X10X20 (Ref # 39156)	39156-2580	1
DAMPER,10X20X12 (Ref # 92160)	92160-1167	2
DAMPER (Ref # 92160A)	92160-1613	1
SCREW,CROSS,5X14 (Ref # 92172)	92172-1438	2
SCREW,TAPPING,3X14 (Ref # 92172A)	92172-1571	7