

2023 NINJA® ZX™ -14R ABS PARTS DIAGRAM

Fuel Injection

E1530

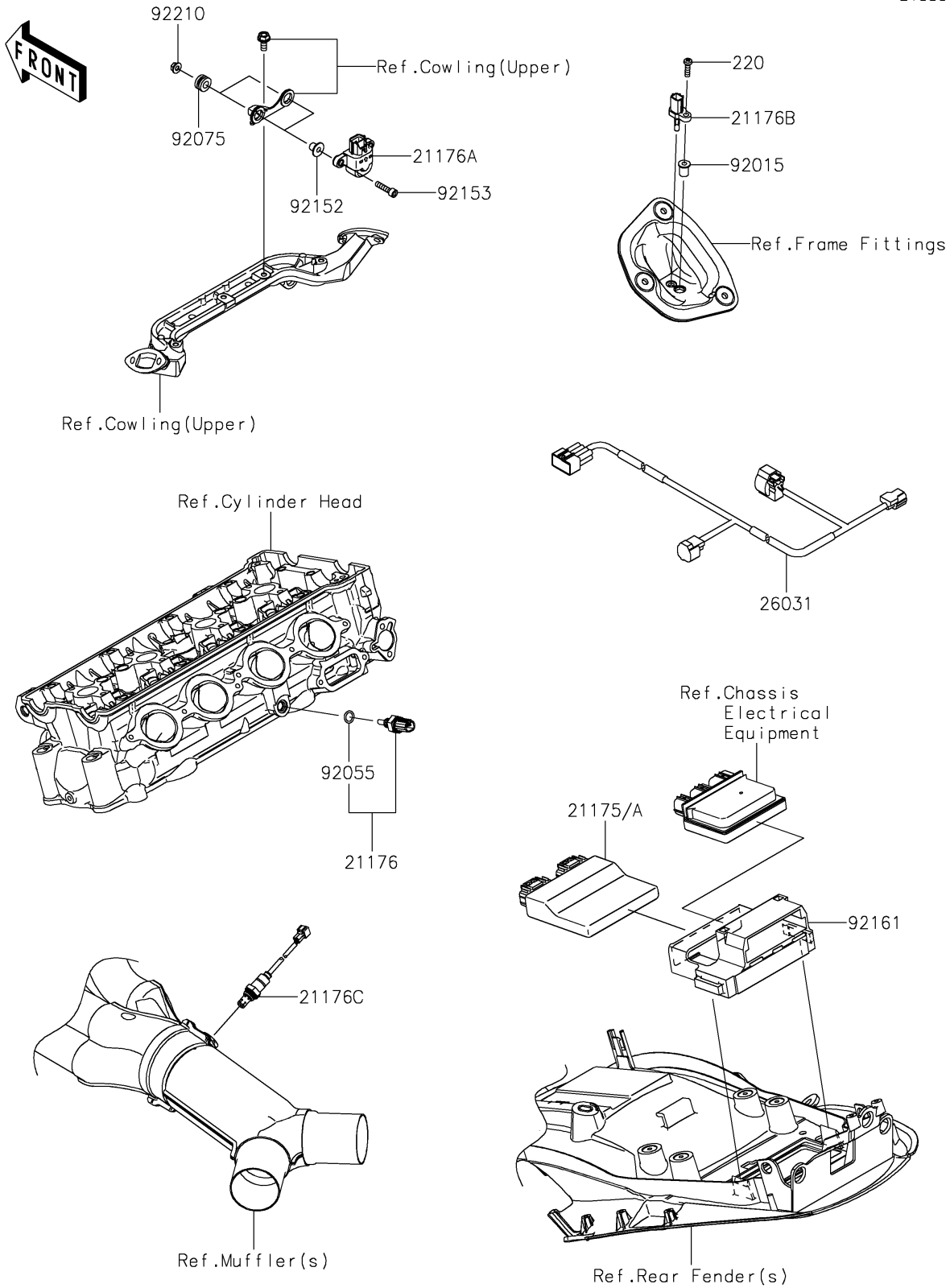

2023 NINJA® ZX™ -14R ABS PARTS LIST

Fuel Injection

ITEM NAME	PART NUMBER	QUANTITY
CONTROL UNIT-ELECTRONIC (Ref # 21175)	21175-1123	1
CONTROL UNIT-ELECTRONIC (Ref # 21175A)	21175-1124	1
SENSOR,WATER TEMP (Ref # 21176)	21176-0009	1
SENSOR,VEHICLE-DOWN (Ref # 21176A)	21176-0026	1
SENSOR,AIR TEMPERATURE (Ref # 21176B)	21176-0048	1
SENSOR,OXYGEN (Ref # 21176C)	21176-0090	1
HARNESS (Ref # 26031)	26031-1385	1
NUT,WELL,5MM (Ref # 92015)	92015-1757	1
RING-O,9.5X1.9 (Ref # 92055)	92055-0016	1
DAMPER (Ref # 92075)	92075-1912	2
COLLAR (Ref # 92152)	92152-0329	2
BOLT,SOCKET,5X22 (Ref # 92153)	92153-1597	2
DAMPER,ECU (Ref # 92161)	92161-1805	1
NUT,FLANGED,5MM (Ref # 92210)	92210-0007	2
SCREW-PAN-CROS,5X18 (Ref # 220)	220AB0518	1