

2023 NINJA® ZX™ -14R ABS PARTS DIAGRAM

Meter(s)

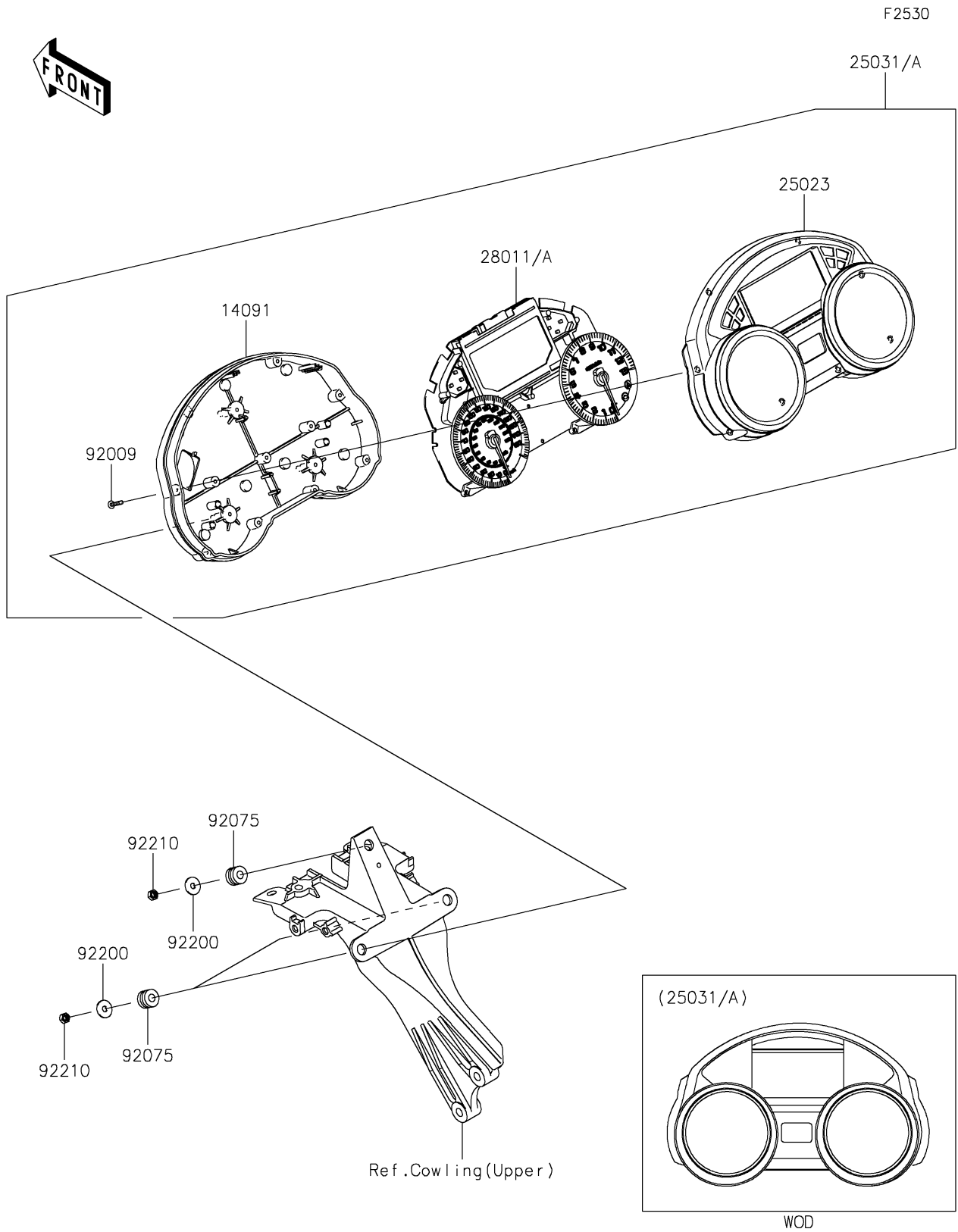

2023 NINJA® ZX™ -14R ABS PARTS LIST

Meter(s)

ITEM NAME	PART NUMBER	QUANTITY
COVER,METER,LWR (Ref # 14091)	14091-0546	1
COVER-METER CASE (Ref # 25023)	25023-0106	1
METER-ASSY,COMBINATION,ABS (Ref # 25031)	25031-0656	1
METER-ASSY,COMBINATION,ABS (Ref # 25031A)	25031-0671	1
METER,SP&TA&LCD (Ref # 28011)	28011-0640	1
METER,SP&TA&LCD (Ref # 28011A)	28011-0644	1
SCREW,TAPPING,3X16 (Ref # 92009)	92009-1391	11
DAMPER (Ref # 92075)	92075-1435	3
WASHER (Ref # 92200)	92200-0288	3
NUT,5MM (Ref # 92210)	92210-0290	3