

1988 NINJA[®] 750R PARTS DIAGRAM

Cylinder Head

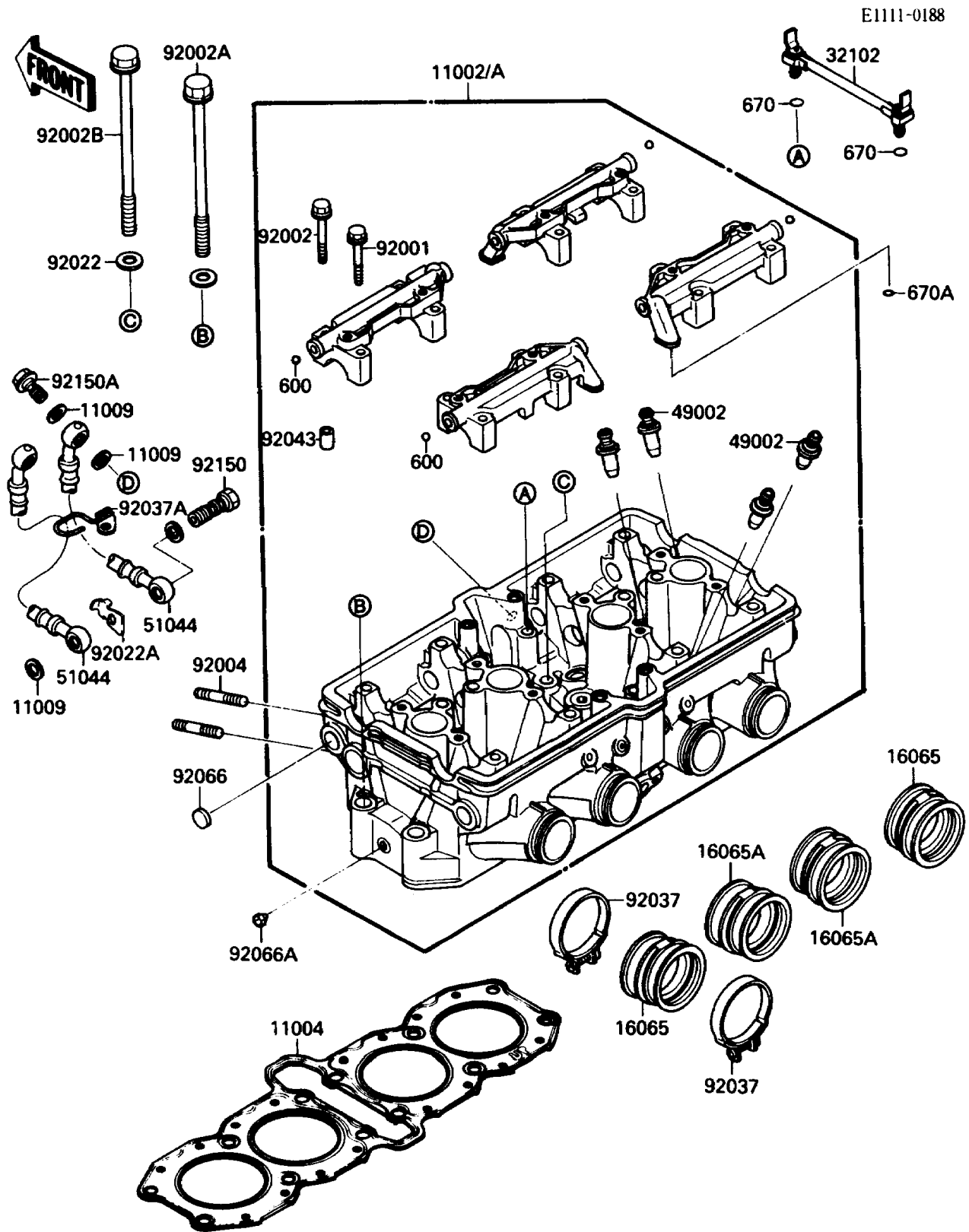

1988 NINJA® 750R PARTS LIST

Cylinder Head

| ITEM NAME | PART NUMBER | QUANTITY |
|--|-------------|----------|
| BALL-STEEL,1/4" (Ref # 600) | 600A0800 | 8 |
| O RING (Ref # 670) | 670D1505 | 4 |
| O RING,8MM (Ref # 670A) | 670D1508 | 4 |
| GASKET-HEAD (Ref # 11004) | 11004-1154 | 1 |
| GASKET,10X14.5X1.5 (Ref # 11009) | 11009-1105 | 6 |
| HOLDER-CARBURETOR,#1 (Ref # 16065) | 16065-1147 | 2 |
| HOLDER-CARBURETOR,#2 (Ref # 16065A) | 16065-1148 | 2 |
| PIPE,CYLINDER HEAD (Ref # 32102) | 32102-1242 | 2 |
| GUIDE-VALVE (Ref # 49002) | 49002-1060 | 16 |
| TUBE-ASSY,OIL PAN-HEAD (Ref # 51044) | 51044-1078 | 2 |
| BOLT,FLANGED,6X38 (Ref # 92001) | 92001-1105 | 8 |
| BOLT,6X46 (Ref # 92002) | 92001-1872 | 8 |
| BOLT,10X148 (Ref # 92002A) | 92002-1798 | 8 |
| BOLT,10X158 (Ref # 92002B) | 92002-1799 | 4 |
| STUD,8X30,BLACK (Ref # 92004) | 92004-1101 | 8 |
| WASHER,10.5X20X1.6 (Ref # 92022) | 92022-1591 | 12 |
| WASHER,OIL PUMP (Ref # 92022A) | 92022-1875 | 1 |
| CLAMP (Ref # 92037) | 92037-1637 | 8 |
| CLAMP (Ref # 92037A) | 92037-1802 | 1 |
| PIN,6.2X8X14 (Ref # 92043) | 92043-1263 | 8 |
| PLUG,ROCKER SHAFT (Ref # 92066) | 92066-1265 | 4 |
| PLUG (Ref # 92066A) | 92066-1266 | 2 |
| BOLT,BANJO,10X37 (Ref # 92150) | 92150-1122 | 1 |
| BOLT,BANJO,10X23 (Ref # 92150A) | 92150-1123 | 2 |
| HEAD-ASSY-CYLINDER (Ref # 11002) | 11002-1225 | 1 |
| HEAD-ASSY-CYLINDER (Ref # 11002A) | 11002-1226 | 1 |