

1989 Ninja® 750R PARTS DIAGRAM

Breather Cover/Oil Pan

E1432-0039

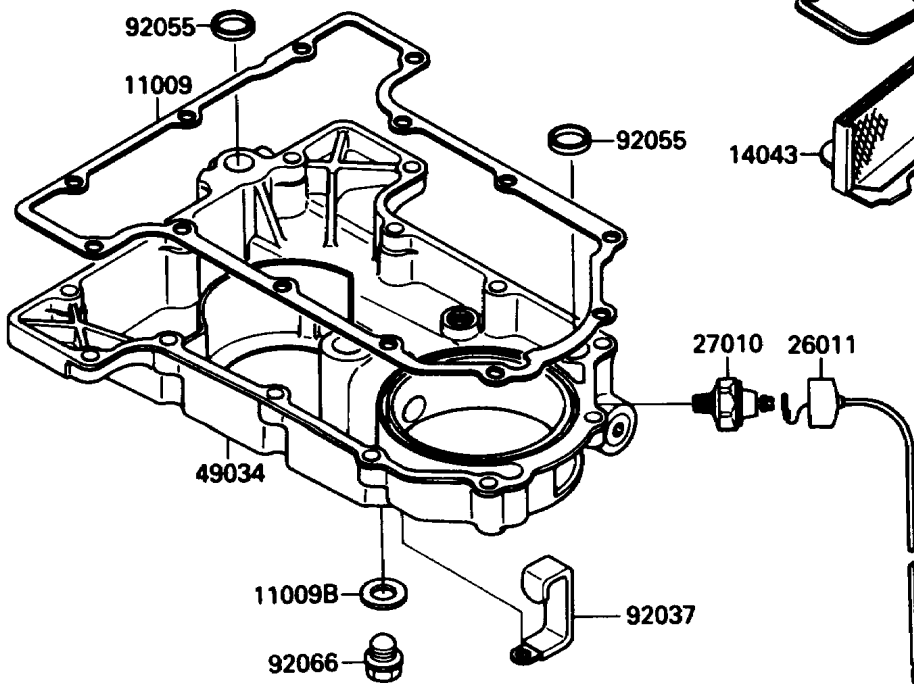
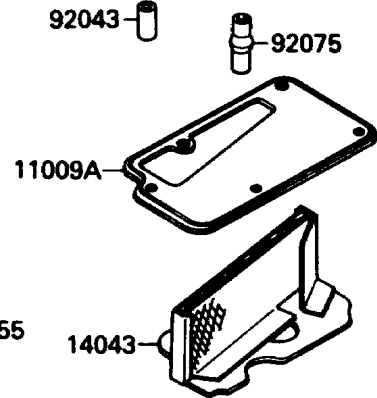
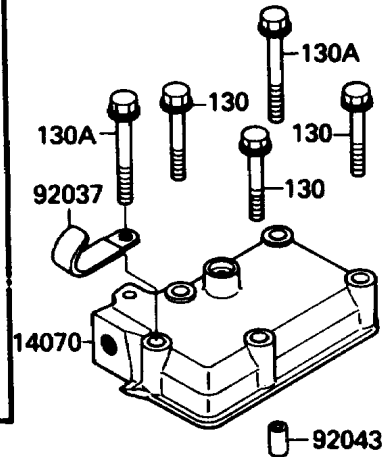
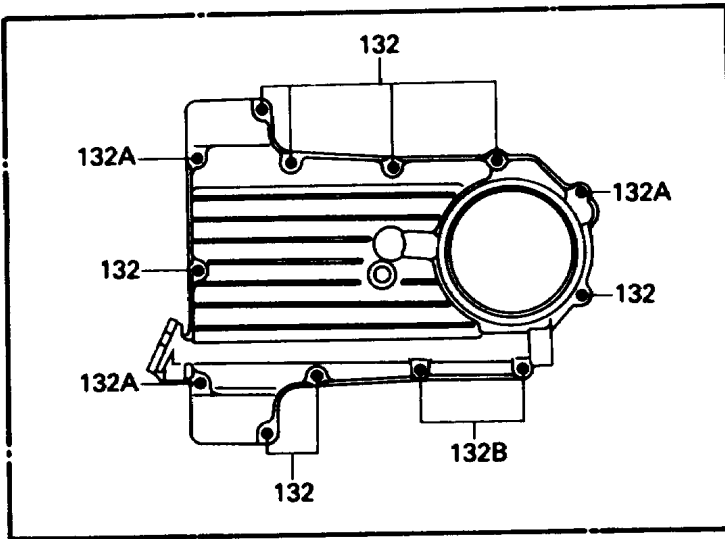

1989 Ninja® 750R PARTS LIST

Breather Cover/Oil Pan

ITEM NAME	PART NUMBER	QUANTITY
BOLT-FLANGED (Ref # 130)	130S0640	3
BOLT-FLANGED (Ref # 130A)	130S0650	2
BOLT-FLANGED-SMALL (Ref # 132)	132W0625	8
BOLT-FLANGED-SMALL (Ref # 132A)	132W0640	3
BOLT-FLANGED-SMALL (Ref # 132B)	132W0655	2
O RING,90MM (Ref # 671)	671B2590	1
GASKET,OIL PAN (Ref # 11009)	11009-1602	1
GASKET,BREATHER COVER (Ref # 11009A)	11009-1604	1
GASKET,12X22X2,DRAIN PLUG (Ref # 11009B)	92065-097	1
FILTER,BREATHER (Ref # 14043)	14043-1062	1
BODY-BREATHER (Ref # 14070)	14070-1066	1
WIRE-LEAD,OIL PRESSURE (Ref # 26011)	26011-1383	1
SWITCH,OIL PRESSURE (Ref # 27010)	27010-1155	1
PAN-OIL (Ref # 49034)	49034-1067	1
CLAMP,WIRING HARNESS (Ref # 92037)	92037-1877	2
PIN,DOWEL,6.3X8X14 (Ref # 92043)	92042-007	2
RING-O,19.5MM (Ref # 92055)	92055-077	2
PLUG,OIL DRAIN,12X15 (Ref # 92066)	92066-1174	1
DAMPER,BREATHER BODY (Ref # 92075)	92075-1958	1