

1989 Ninja® 750R PARTS DIAGRAM

Oil Pump/Oil Filter

E1710-0083

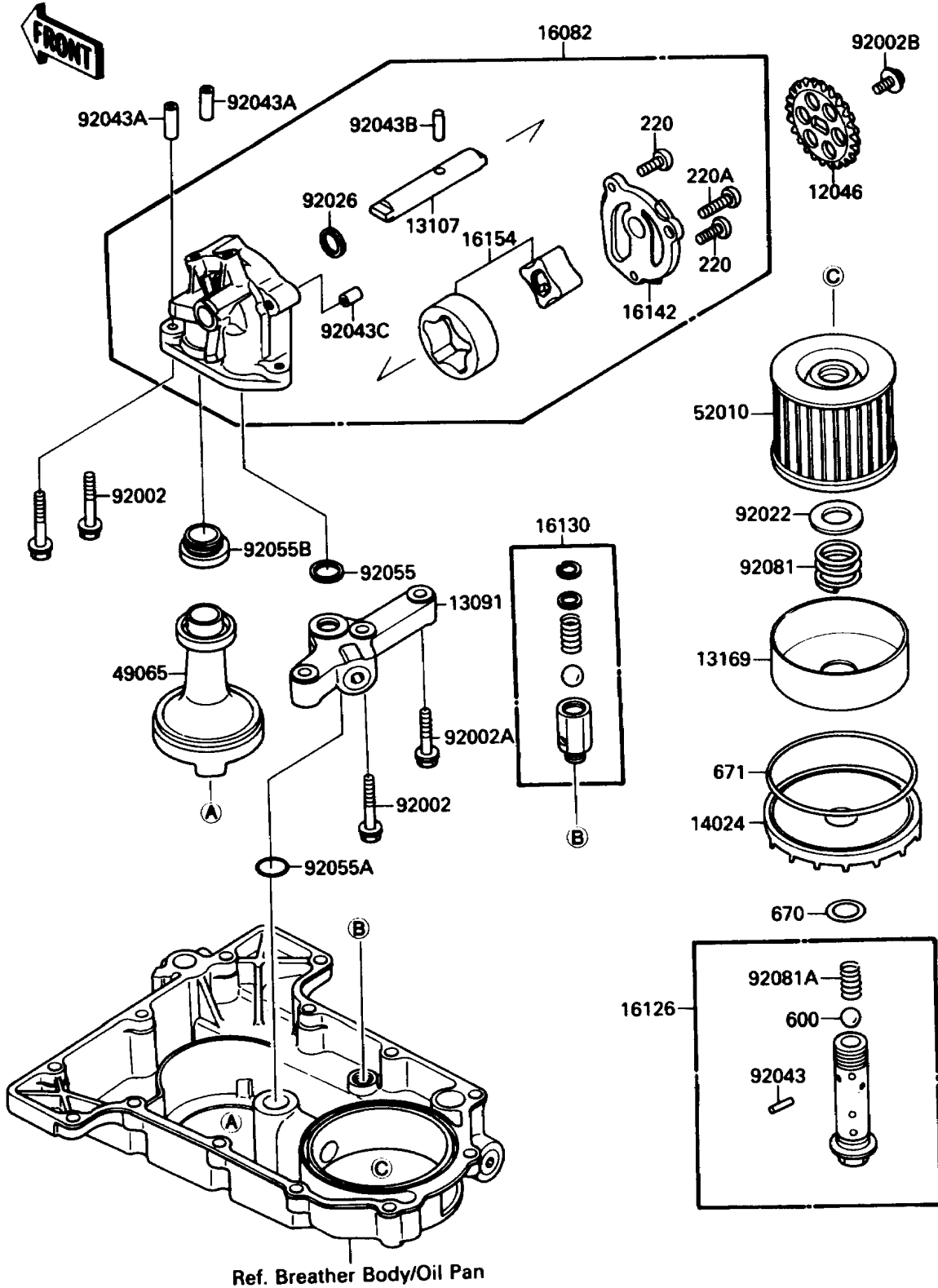

1989 Ninja® 750R PARTS LIST

Oil Pump/Oil Filter

ITEM NAME	PART NUMBER	QUANTITY
SCREW-PAN-CROS,6X16 (Ref # 220)	220B0616	2
SCREW-PAN-CROS,6X20,WHITE (Ref # 220A)	220B0620	1
BALL-STEEL,3/8" (Ref # 600)	600A1200	1
O RING,16MM (Ref # 670)	670B2016	1
O RING,90MM (Ref # 671)	671B2590	1
SPROCKET,25T (Ref # 12046)	12046-1093	1
HOLDER,OIL PUMP (Ref # 13091)	13091-1439	1
SHAFT (Ref # 13107)	13107-1199	1
PLATE,OIL FILTER (Ref # 13169)	13169-1110	1
COVER,OIL FILTER (Ref # 14024)	16101-004	1
PUMP-ASSY-OIL (Ref # 16082)	16082-1083	1
VALVE,OIL FILTER (Ref # 16126)	16126-1108	1
VALVE-ASSY-RELIEF (Ref # 16130)	16130-1001	1
COVER-PUMP (Ref # 16142)	16142-1075	1
ROTOR-PUMP (Ref # 16154)	16154-1063	1
FILTER-OIL (Ref # 49065)	49065-1056	1
ELEMENT-OIL FILTER (Ref # 52010)	16099-003	1
BOLT,6X38 (Ref # 92002)	92002-1431	3
BOLT,6X30 (Ref # 92002A)	92002-1797	2
BOLT,6X14 (Ref # 92002B)	92002-1859	1
WASHER,20.5X30X1 (Ref # 92022)	92022-1012	1
SPACER (Ref # 92026)	92026-1284	1
PIN,SPRING,2X20 (Ref # 92043)	92043-111	1
PIN,6.2X8X21 (Ref # 92043A)	92043-1335	2
PIN (Ref # 92043B)	92043-1353	1
PIN (Ref # 92043C)	92043-1354	1
RING-O,19.5MM (Ref # 92055)	92055-077	1
RING-O,16.3X3.5 (Ref # 92055A)	92055-1353	1
RING-O,OIL FILTER (Ref # 92055B)	92055-1354	1

1989 Ninja® 750R PARTS LIST

Oil Pump/Oil Filter

ITEM NAME	PART NUMBER	QUANTITY
SPRING,OIL FILTER (Ref # 92081)	92081-1018	1
SPRING (Ref # 92081A)	92081-109	1