

# 1989 Ninja® 750R PARTS DIAGRAM

Handlebar

F2310-0399

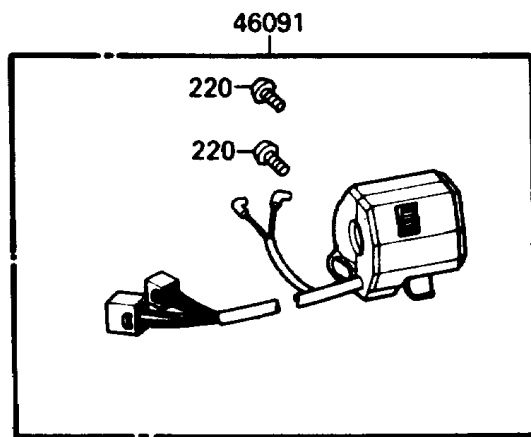
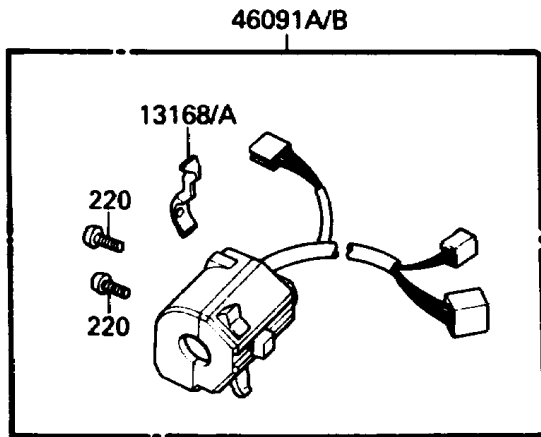
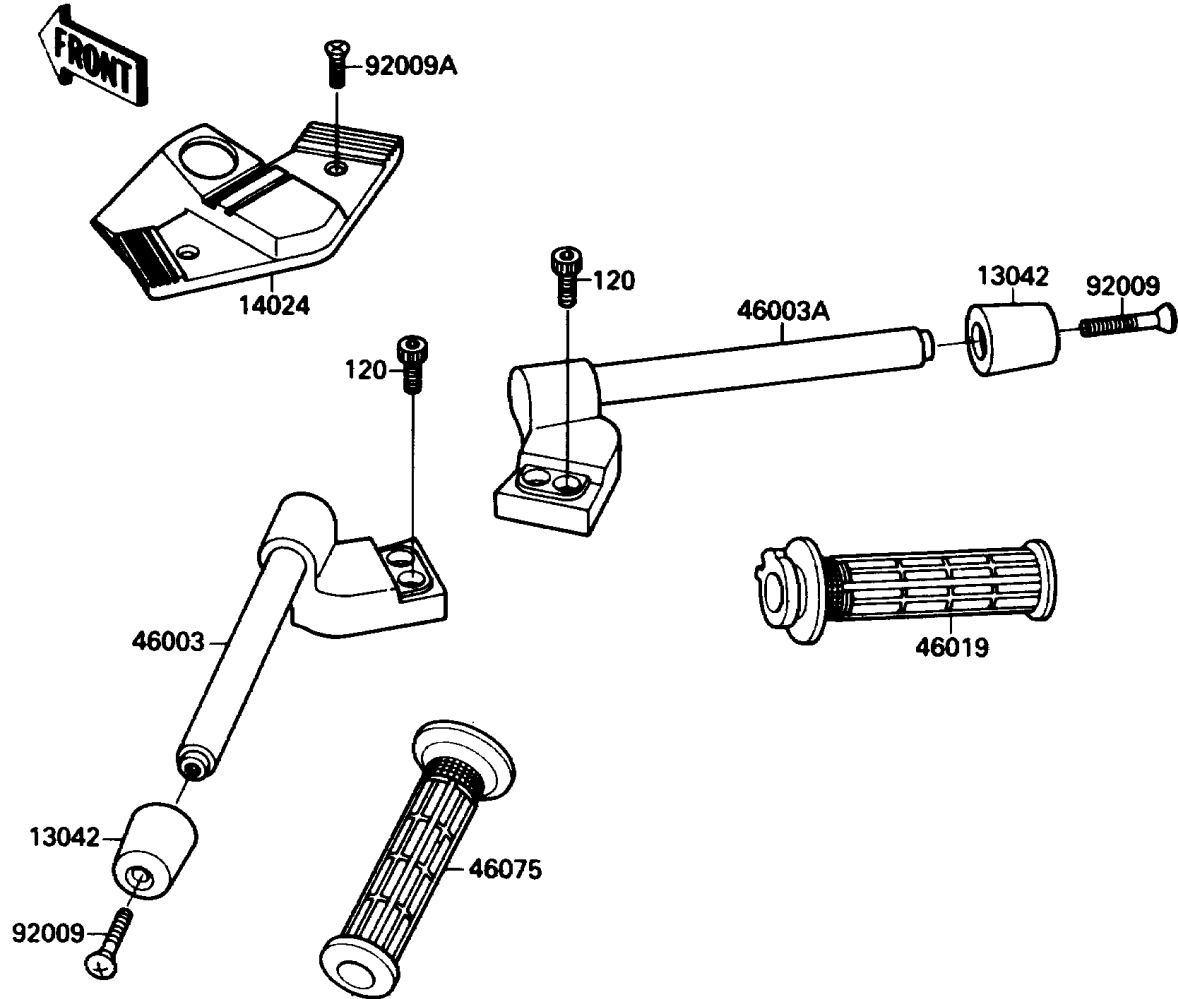

# 1989 Ninja® 750R PARTS LIST

## Handlebar

ITEM NAME	PART NUMBER	QUANTITY
BOLT-SOCKET,8X20 (Ref # 120)	120S0820	4
SCREW-PAN-CROS (Ref # 220)	220C0520	4
WEIGHT,HANDLE (Ref # 13042)	13042-1005	2
LEVER,CHOKE (Ref # 13168A)	13168-1374	1
COVER,STEERING HEAD (Ref # 14024)	14024-1302	1
HANDLE,LH (Ref # 46003)	46003-1230	1
HANDLE,RH (Ref # 46003A)	46003-1231	1
GRIP-ASSY,THROTTLE (Ref # 46019)	46019-1059	1
GRIP,LH (Ref # 46075)	46075-1028	1
HOUSING-ASSY-CONTROL,RH (Ref # 46091)	46091-1439	1
HOUSING-ASSY-CONTROL,LH (Ref # 46091B)	46091-1482	1
SCREW,8X45 (Ref # 92009)	92009-1257	2
SCREW,5X18 (Ref # 92009A)	92009-1328	2