

1989 Ninja® 750R PARTS DIAGRAM

Ignition Switch/Locks/Reflectors

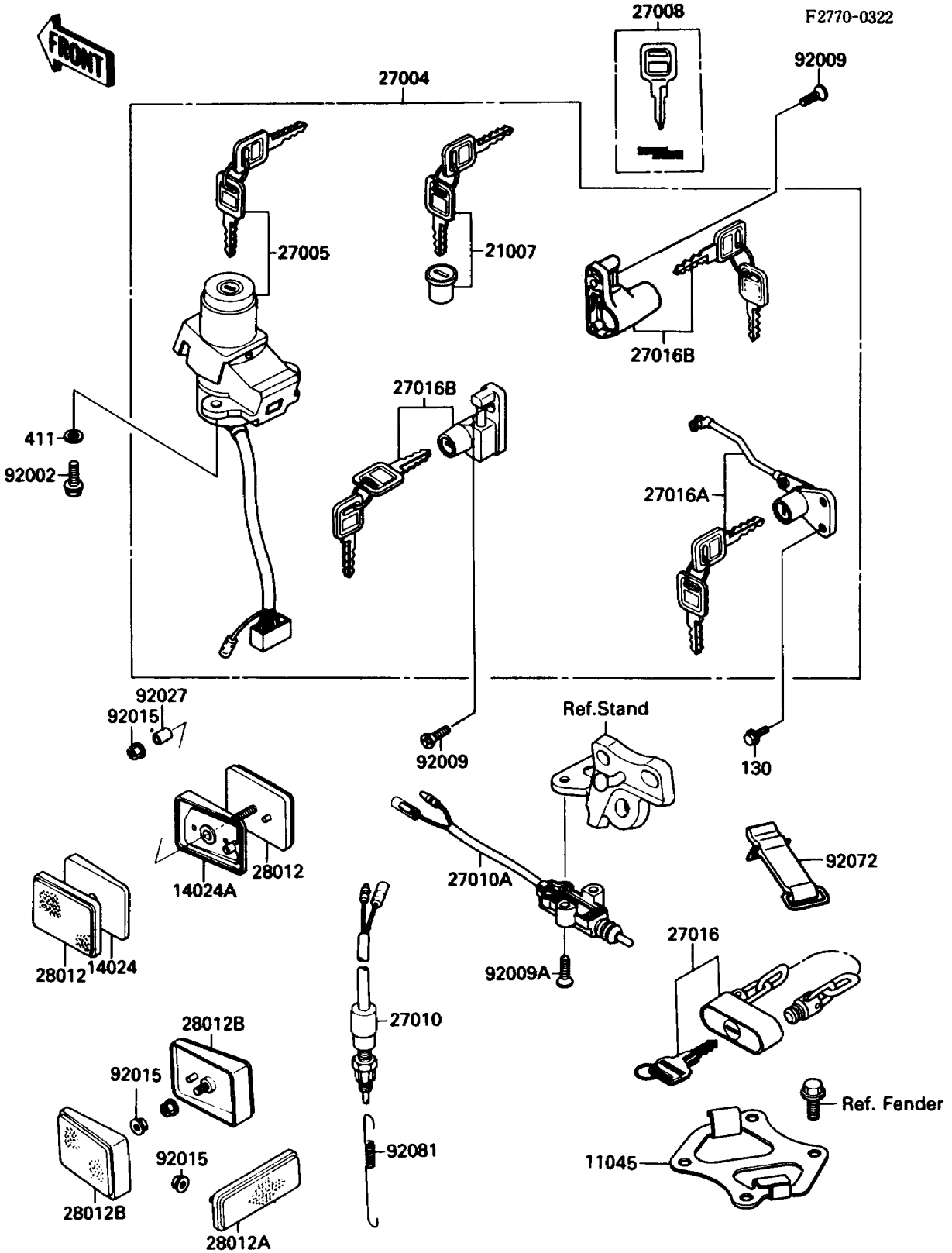

1989 Ninja® 750R PARTS LIST

Ignition Switch/Locks/Reflectors

ITEM NAME	PART NUMBER	QUANTITY
BOLT-FLANGED (Ref # 130)	130C0510	2
WASHER-PLAIN,6MM (Ref # 411)	411E0600	2
BRACKET,CHAIN LOCK (Ref # 11045)	11045-1678	1
COVER,REFLECTOR,FR (Ref # 14024)	14025-1886	1
COVER,REFLECTOR,FR (Ref # 14024A)	14025-1887	1
ROTOR,LOCK,TANK CAP (Ref # 21007)	21007-5019	1
SWITCH-ASSY (Ref # 27004)	27004-5294	1
SWITCH-ASSY-IGNITION (Ref # 27005)	27005-5067	1
KEY-LOCK,BLANK (Ref # 27008)	27008-1103	1
SWITCH,BRAKE LAMP (Ref # 27010)	27010-1093	1
SWITCH,SIDE STAND (Ref # 27010A)	27010-1223	1
LOCK-ASSY,WHEEL (Ref # 27016)	27016-1051	1
LOCK-ASSY,SEAT (Ref # 27016A)	27016-5118	1
LOCK-ASSY,HELMET (Ref # 27016B)	27016-5121	2
REFLECTOR-REFLEX,FR (Ref # 28012)	28012-1052	2
REFLECTOR-REFLEX (Ref # 28012A)	28012-1057	1
REFLECTOR-REFLEX,REAR SIDE (Ref # 28012B)	28012-1061	2
BOLT,TORX,6X16 (Ref # 92002)	92002-1333	2
SCREW,5X12 (Ref # 92009)	92009-1401	2
SCREW,5X20 (Ref # 92009A)	92009-1459	2
NUT,FLANGED,5MM (Ref # 92015)	92015-1259	5
COLLAR,5X8X14.5 (Ref # 92027)	92027-1789	2
BAND (Ref # 92072)	92072-1176	1
SPRING,BRAKE LAMP SWITCH (Ref # 92081)	27011-017	1