

# 1990 Ninja® 750R PARTS DIAGRAM

Cylinder/Piston(s)

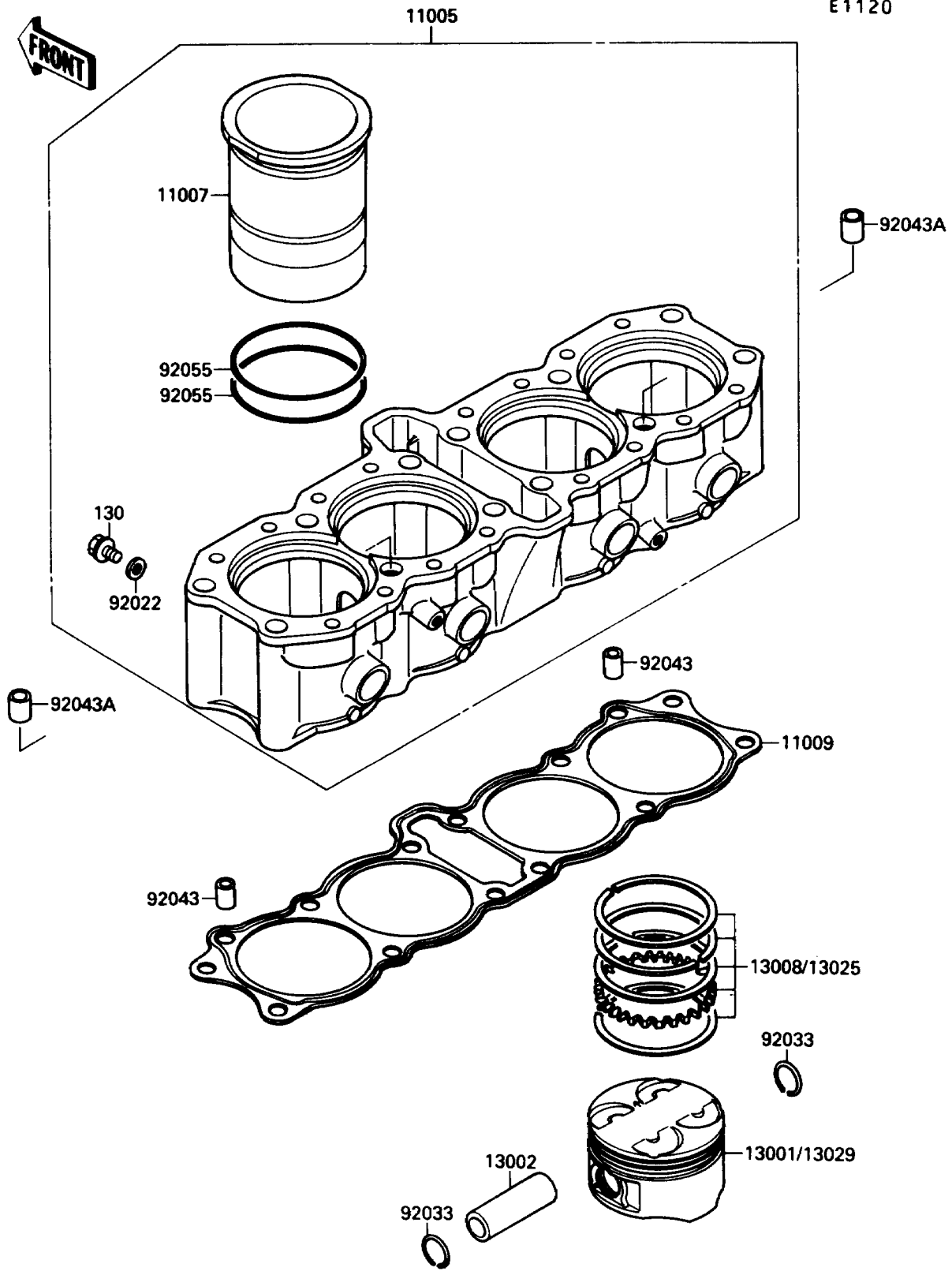

## 1990 Ninja® 750R PARTS LIST

Cylinder/Piston(s)

ITEM NAME	PART NUMBER	QUANTITY
CYLINDER-ENGINE (Ref # 11005)	11005-1502	1
LINER-CYLINDER (Ref # 11007)	11007-1090	4
GASKET,CYLINDER BASE (Ref # 11009)	11009-1777	1
PISTON-ENGINE,STD (Ref # 13001)	13001-1240	4
PIN-PISTON (Ref # 13002)	13002-1065	4
RING-SET-PISTON,STD (Ref # 13008)	13008-1083	4
RING-SET-PISTON L,O/S,0.50 (Ref # 13025)	13025-1079	4
PISTON-ENGINE L,O/S,0.50 (Ref # 13029)	13029-1157	4
WASHER,6.2X11X1 (Ref # 92022)	92022-304	2
RING-SNAP (Ref # 92033)	92033-1054	8
PIN,8.2X10X14 (Ref # 92043)	92043-1264	2
PIN,10.1X12X14 (Ref # 92043A)	92043-4009	2
RING-O,74.6X2.4 (Ref # 92055)	92055-1357	8
BOLT-FLANGED,6X10,BLACK (Ref # 130)	130C0610	2