

1990 Ninja® ZX™-7 PARTS DIAGRAM

Swingarm

F2141

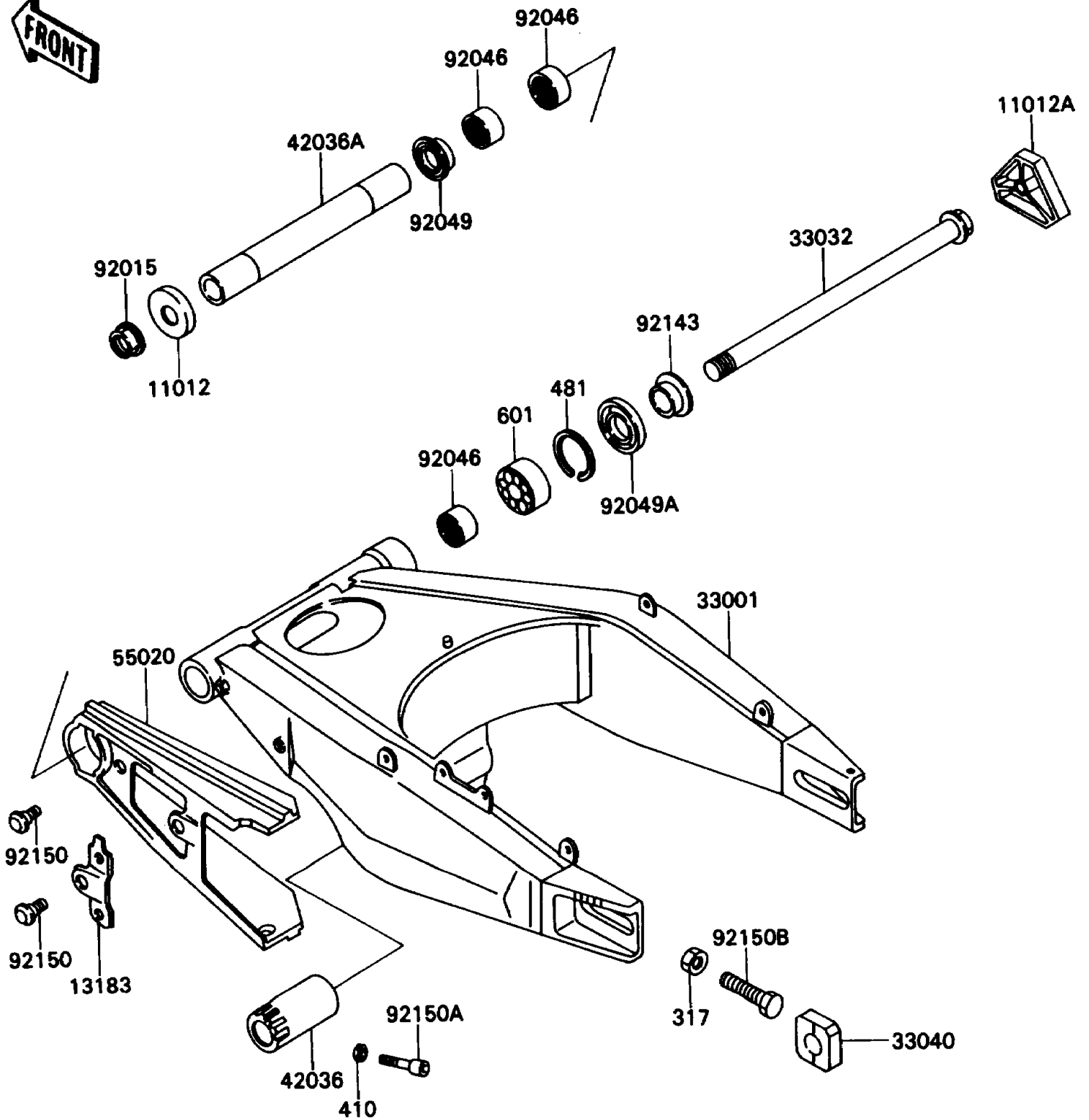

1990 Ninja® ZX™-7 PARTS LIST

Swingarm

ITEM NAME	PART NUMBER	QUANTITY
CAP (Ref # 11012)	11012-1658	1
CAP (Ref # 11012A)	11012-1741	1
PLATE,CHAIN GUARD (Ref # 13183)	13183-1598	1
ARM-COMP-SWING,SILVER NO.25 (Ref # 33001)	33001-1358-CE	1
SHAFT-SWING ARM (Ref # 33032)	33032-1158	1
ADJUSTER-CHAIN (Ref # 33040)	33040-1109	2
SLEEVE,SWING ARM,L=84 (Ref # 42036)	42036-1253	1
SLEEVE,SWING ARM,L=237 (Ref # 42036A)	42036-1268	1
GUARD,CHAIN (Ref # 55020)	55020-1373	1
NUT,FLANGED,20MM (Ref # 92015)	92015-1724	1
BEARING-NEEDLE,BM283417 (Ref # 92046)	92046-1111	3
SEAL-OIL (Ref # 92049)	92049-1181	1
SEAL-OIL,MHSA25 42 6 (Ref # 92049A)	92049-1314	1
COLLAR,SWING ARM,L=12.5 (Ref # 92143)	92143-1227	1
BOLT,6MM (Ref # 92150)	92150-1193	2
BOLT,SOCKET,10X25 (Ref # 92150A)	92150-1267	2
BOLT,8X55 (Ref # 92150B)	92150-1350	2
NUT-HEX-SMALL,8MM (Ref # 317)	317G0800	2
W-PLAIN-S (Ref # 410)	410E1000	2
CIRCLIP-TYPE-C,42MM (Ref # 481)	481J4200	1
BEARING-BALL,#6004 (Ref # 601)	601A6004	1