

2006 KX85 PARTS DIAGRAM

Generator

E1810

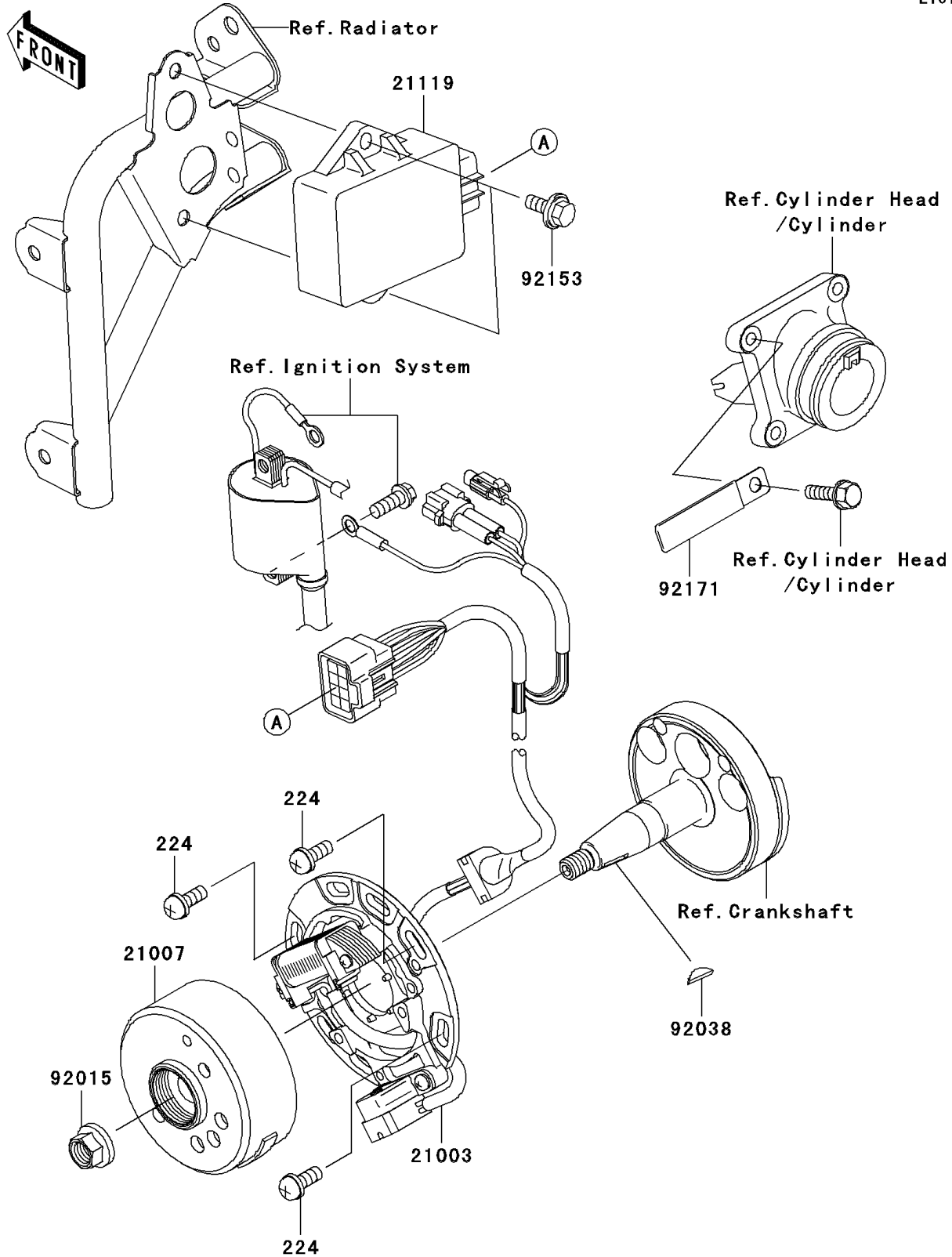

2006 KX85 PARTS LIST

Generator

ITEM NAME	PART NUMBER	QUANTITY
SCREW-PAN-WP-CROS,6X14 (Ref # 224)	224AA0614	3
STATOR (Ref # 21003)	21003-0032	1
ROTOR (Ref # 21007)	21007-0073	1
IGNITER (Ref # 21119)	21119-0048	1
NUT,FLANGED,10MM (Ref # 92015)	92015-077	1
KEY,WOODRUFF (Ref # 92038)	92038-001	1
BOLT,6X16 (Ref # 92153)	92153-0863	2
CLAMP (Ref # 92171)	92171-0652	1