

1996 Ninja® ZX™-7RR PARTS DIAGRAM

Handlebar

F2310

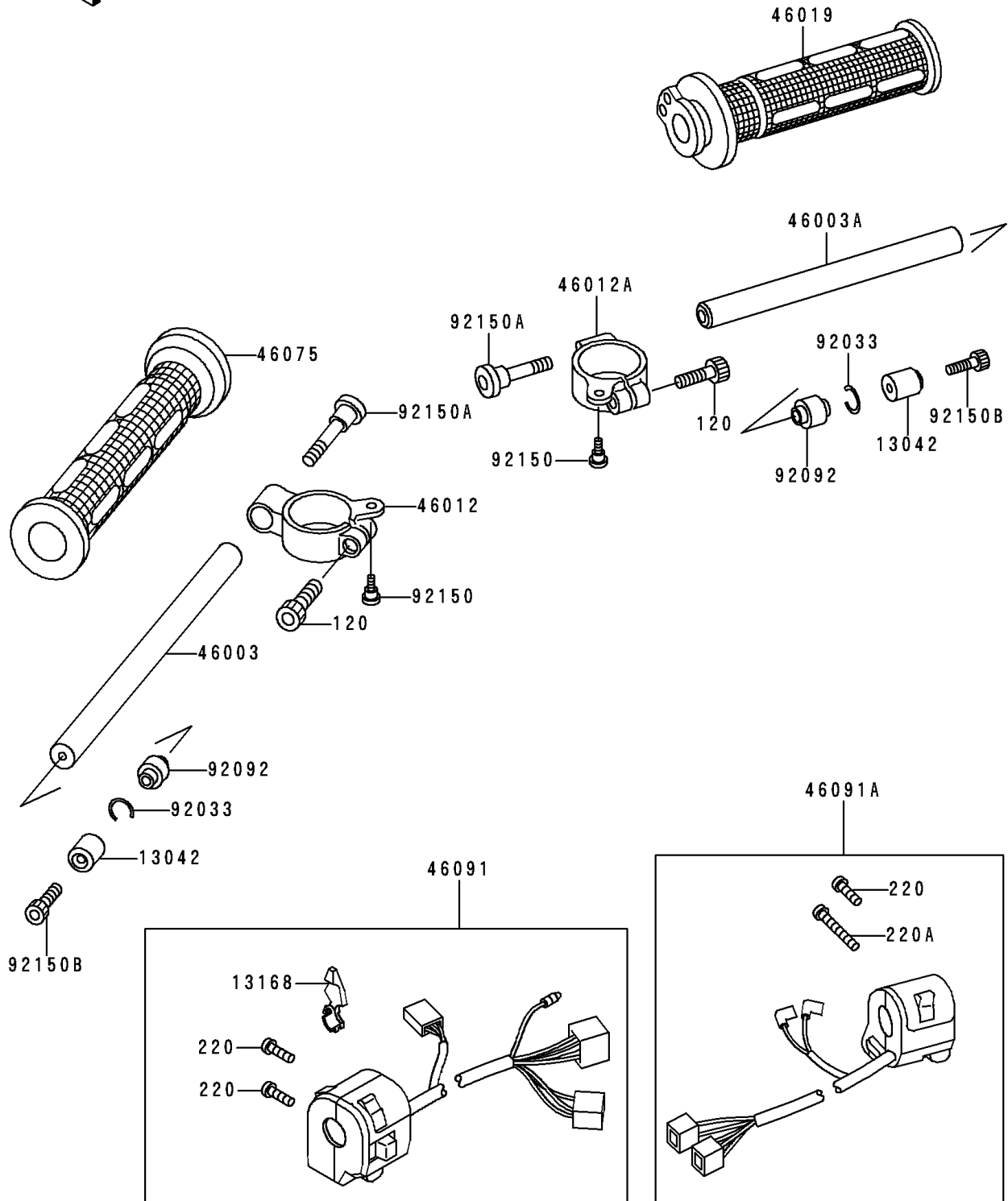

1996 Ninja® ZX™-7RR PARTS LIST

Handlebar

ITEM NAME	PART NUMBER	QUANTITY
BOLT-SOCKET,8X30 (Ref # 120)	120P0830	2
SCREW-PAN-CROS (Ref # 220)	220C0525	3
SCREW-PAN-CROS (Ref # 220A)	220C0540	1
WEIGHT,HANDLE (Ref # 13042)	13042-1006	2
LEVER,CHOKE (Ref # 13168)	13168-1516	1
HANDLE,LH (Ref # 46003)	46003-1442	1
HANDLE,RH (Ref # 46003A)	46003-1443	1
HOLDER-HANDLE,LH (Ref # 46012)	46012-1236	1
HOLDER-HANDLE,RH (Ref # 46012A)	46012-1237	1
GRIP-ASSY,THROTTLE (Ref # 46019)	46019-1077	1
GRIP,LH (Ref # 46075)	46075-1088	1
HOUSING-ASSY-CONTROL,LH (Ref # 46091)	46091-1671	1
HOUSING-ASSY-CONTROL,RH (Ref # 46091A)	46091-1672	1
RING-SNAP,OD=22.2 (Ref # 92033)	92033-1102	2
BUSHING-RUBBER,HANDLE (Ref # 92092)	92092-1018	2
BOLT,6MM (Ref # 92150)	92150-1090	2
BOLT,SOCKET,10X37 (Ref # 92150A)	92150-1469	2
BOLT,SOCKET,8X30 (Ref # 92150B)	92150-1604	2