

2003 Ninja® ZX™-7R PARTS DIAGRAM

Side Covers/Chain Cover

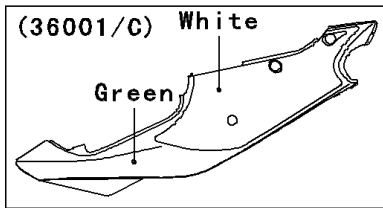

WOD

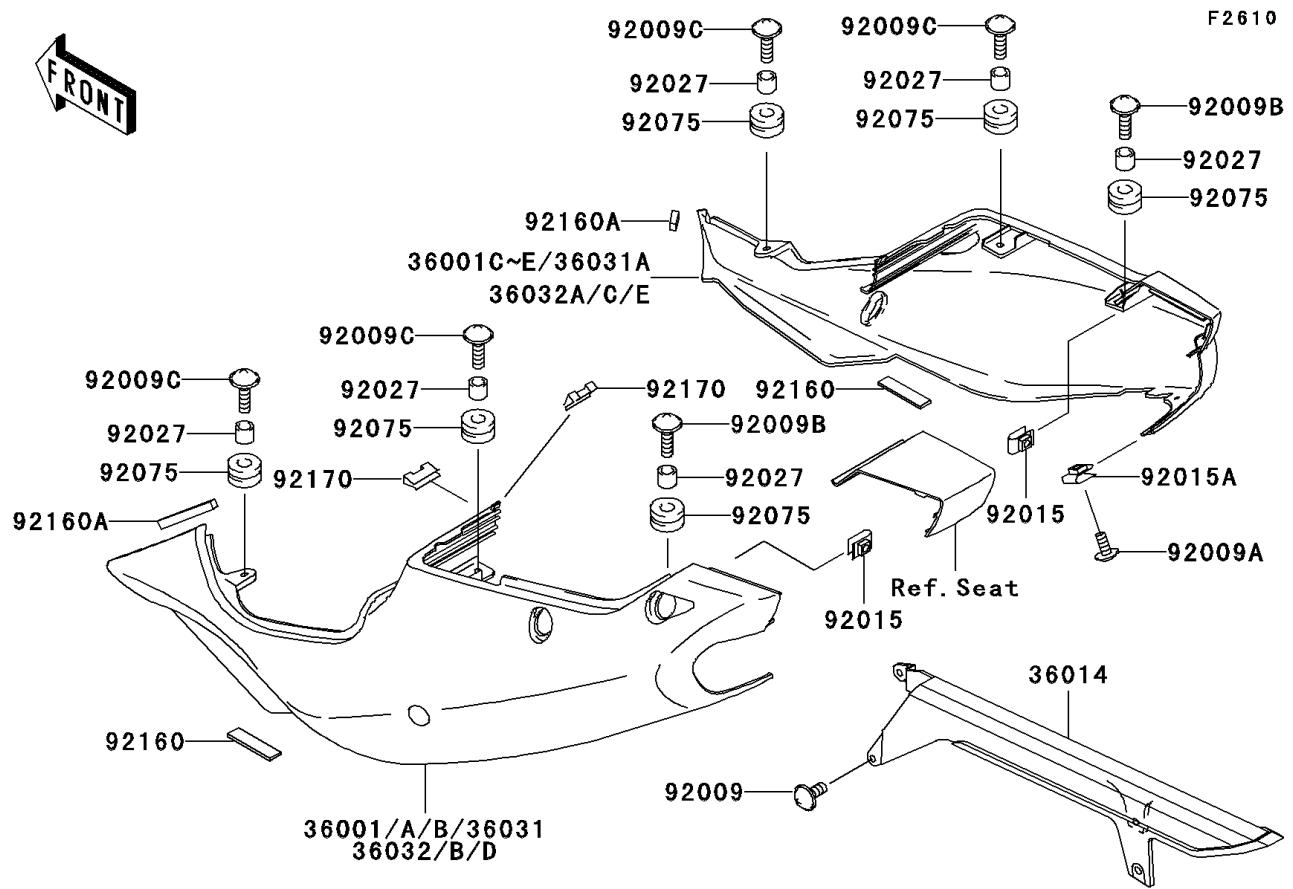
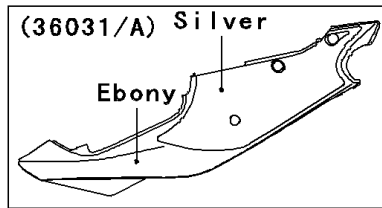

WD

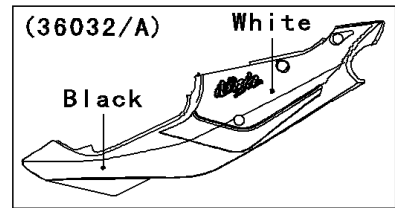

WD

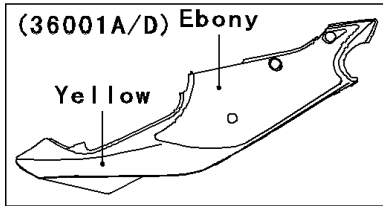

WOD

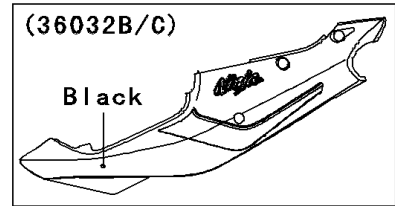

WD

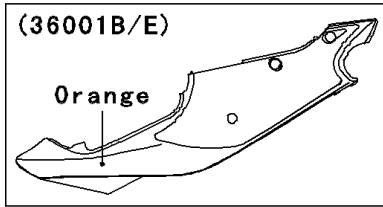

WOD

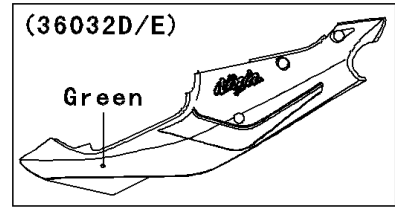

WD

2003 Ninja® ZX™ -7R PARTS LIST

Side Covers/Chain Cover

ITEM NAME	PART NUMBER	QUANTITY
COVER-SIDE,LH,P.B.ORANGE (Ref # 36001B)	36001-1557-470	1
COVER-SIDE,RH,P.B.ORANGE (Ref # 36001E)	36001-1558-470	1
CASE-CHAIN (Ref # 36014)	36014-1200	1
COVER-SIDE,LH,L.GREEN (Ref # 36032D)	36032-5168-7F	1
COVER-SIDE,RH,L.GREEN (Ref # 36032E)	36032-5169-7F	1
SCREW,6X10 (Ref # 92009)	92009-1402	4
SCREW,5X14 (Ref # 92009A)	92009-1653	1
SCREW,6X18 (Ref # 92009B)	92009-1663	2
SCREW,6X22 (Ref # 92009C)	92009-1664	4
NUT,5MM (Ref # 92015)	92015-1798	2
NUT,5MM (Ref # 92015A)	92015-1996	1
COLLAR,6.8X10X8.5 (Ref # 92027)	92027-129	6
DAMPER (Ref # 92075)	92075-1634	6
DAMPER (Ref # 92160)	92160-1099	2
DAMPER (Ref # 92160A)	92160-1800	2
CLAMP (Ref # 92170)	92170-1440	2