

1996 Ninja® ZX™-9R PARTS DIAGRAM

Gear Change Mechanism

E1370

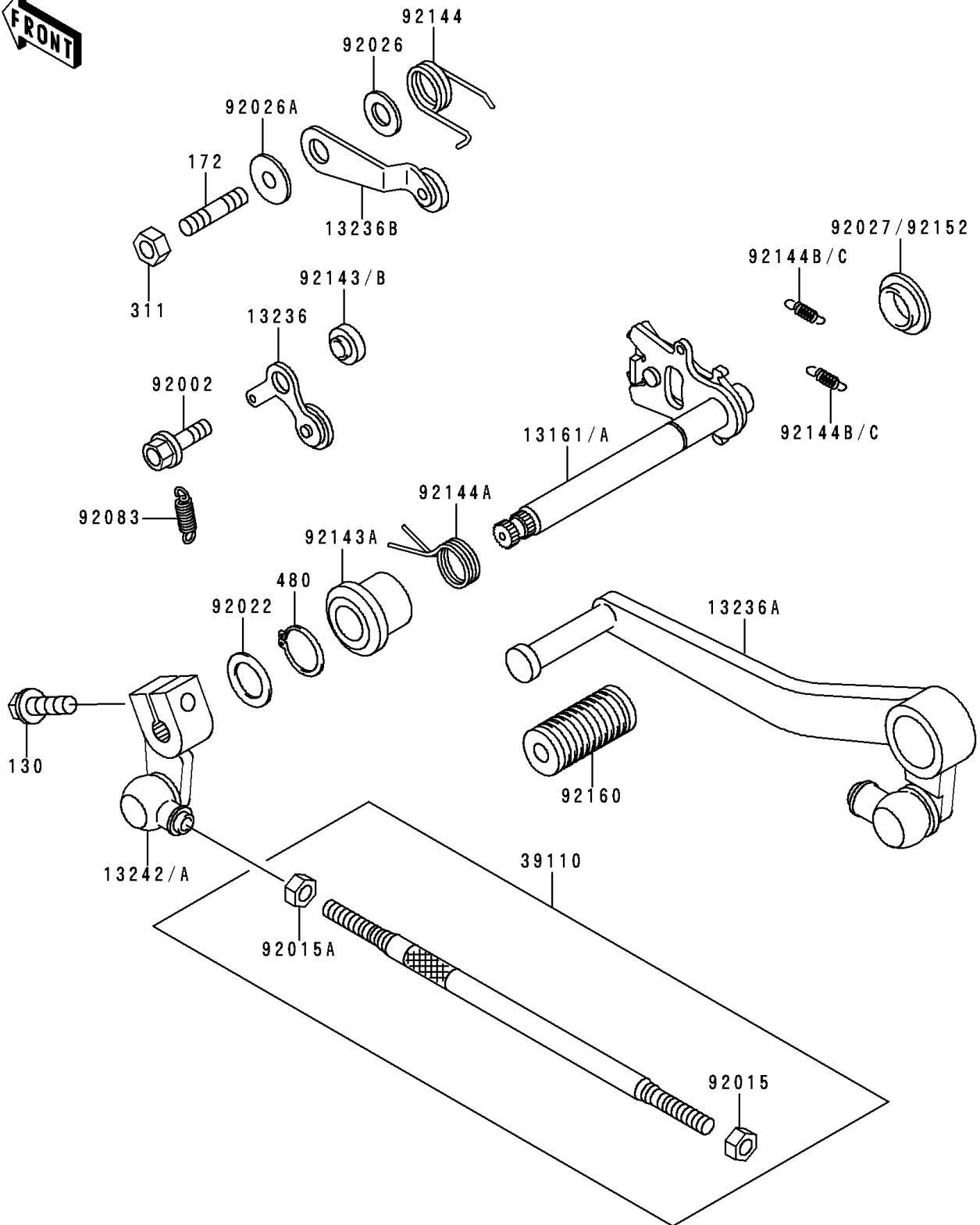

1996 Ninja® ZX™-9R PARTS LIST

Gear Change Mechanism

ITEM NAME	PART NUMBER	QUANTITY
BOLT-FLANGED,6X20,BLACK (Ref # 130)	130S0620	1
CIRCLIP-TYPE-C,13MM (Ref # 480)	480J1300	1
LEVER-COMP-CHANGE SHAFT (Ref # 13161)	13161-1193	1
LEVER-COMP,POSITION (Ref # 13236)	13236-1189	1
LEVER-COMP,CHANGE PEDAL (Ref # 13236A)	13236-1254	1
LEVER-ASSY-CHANGE (Ref # 13242A)	13242-1326	1
ROD-ASSY-TIE (Ref # 39110)	39110-1105	1
BOLT,6X16 (Ref # 92002)	92002-1571	1
NUT,LH,THREAD (Ref # 92015)	92015-1443	1
NUT,RH,THREAD (Ref # 92015A)	92015-1444	1
WASHER,13.3X20X1 (Ref # 92022)	92022-1496	1
SPRING,CHANGE DRUM LEVER (Ref # 92083)	92083-012	1
COLLAR (Ref # 92143)	92143-1055	1
COLLAR,RETURN SPRING (Ref # 92143A)	92143-1498	1
SPRING,CHANGE SHAFT RETURN (Ref # 92144A)	92144-1628	1
SPRING,CHANGE LEVER (Ref # 92144C)	92144-1975	2
COLLAR (Ref # 92152)	92152-1075	1
DAMPER,CHANGE PEDAL (Ref # 92160)	92160-1036	1